



moree®
ENHANCING AMBIANCE



ÜBER MOREE

ABOUT MOREE | A PROPOS DE MOREE

DE Moree ist Spezialist für hochwertige Leuchten, Leucht- und Objektmöbel, gemacht für Menschen, die sinnliches wie urbanes Wohnen schätzen. Aus der Liebe zu klaren Formen, innovativen Materialien und der Faszination für die Wirkung von Licht schöpfen die Moree Designer immer neue Ideen für ausdrucksstarkes wie zeitloses Interieur & Exterieur.

Moree steht für formschöne und hochfunktionale Qualitätsprodukte, welche im ausgesuchten Einrichtungs- und Designfachhandel in über 30 Ländern erhältlich sind.

Das Sortiment basiert zudem auf einer umfangreichen Kollektion an Leuchttischen und Sitzmöbeln für alle Anwendungsbereiche der Gastronomie und Hotellerie.

Unser Service und die schnelle Verfügbarkeit von Ersatzteilen ist nicht nur bei gewerblichen Kunden unentbehrlich. Wir achten bei der Konzeption von Produkten auf mögliche Verwendung von Austauschteilen und halten ein Ersatzteillager vor, das schnelle Reparaturen von Produkten ermöglicht.

Wir bieten die Möglichkeit, unsere Produkte individuell zu bedrucken und so Ihre Marke oder Botschaften prominent zu positionieren. >Individuell, aufmerksamkeitsstark und faszinierend.<

EN Moree is a specialist in high-quality lighting and furniture, made for people who appreciate sensual, urban living.

With the love of clear forms, innovative materials combined with a fascination for the effect of light, Moree designers are always exploring expressive and timeless ideas for interiors and exteriors.

Moree combines exquisite forms with highly functional products, available in over 30 countries in selected furnishing and design stores.

The range is based on an extensive collection of illuminated tables and seating for all areas of the hospitality industry.

Good service and the availability of spare parts is essential for both home and contract users. When designing products, we pay attention to the possible need for replacement parts and maintain a spare parts warehouse that enables quick product repairs.

Moree products can be branded individually, giving companies and product advertisements high visibility. >Unique, eye-catching and intriguing.<

FR Moree est un spécialiste des luminaires et des meubles de haute qualité conçus pour les personnes qui apprécient la vie sensuelle et urbaine.

Les designers de Moree s'inspirent de leur amour pour les formes claires, les matériaux innovants et de leur passion pour les jeux de lumière pour créer des intérieurs et extérieurs expressifs et intemporels.

Moree est signe de produits de qualité élégants et parfaitement fonctionnels qui sont proposés dans les magasins de meubles et de design de plus de 30 pays.

La gamme est basée sur une vaste collection de tables lumineuses et meubles d'assise pour tous les domaines d'application de la gastronomie et de l'hôtellerie.

Un bon service et la disponibilité rapide de pièces détachées ne sont pas seulement indispensables pour des clients commerciaux. Lors de la conception des produits, nous prêtons attention à l'utilisation possible de pièces de rechange et maintenons un entrepôt de pièces de rechange qui permet des réparations rapides des produits.

La possibilité d'appliquer des impressions individuelles sur nos produits afin de transporter des marques ou messages de manière exceptionnelle constitue un autre atout. >Individuels, attractifs et fascinants.<

MATERIALIEN

MATERIALS | MATERIAUX

DE Hochwertig & Nachhaltig. Um das anspruchsvolle Qualitätsniveau und die Langlebigkeit der Produkte zu garantieren, werden ausschließlich hochwertige Materialien wie Stahl, Aluminium, Glas, Holzwerkstoffe und Filz verarbeitet. Die einzigartigen, transluzenten Komposit-Kunststoffe wurden exklusiv für Moree entwickelt und produziert. Jedes Produkt überzeugt für sich mit Design, Funktion und Innovation.

EN High-quality & sustainable. In order to guarantee the demanding quality level and durability of the products, only high-quality materials such as steel, aluminium, glass, wood materials and felt are processed. The unique, translucent composite plastics were developed and produced exclusively for Moree. Each product convinces with its own design, function and innovation.

FR Haute qualité & durabilité. Pour garantir le niveau de qualité exigeant et la durabilité des produits, seuls des matériaux de haute qualité tels que l'acier, l'aluminium, le verre, les matériaux dérivés du bois et le feutre sont utilisés. Les matières plastiques composites translucides uniques en leur genre ont été développées et produites exclusivement pour Moree. Chaque produit convainc par son design, sa fonction et son innovation.



LICHT

LIGHT | LUMIÈRE

DE Erst durch Licht werden Farben, Materialien, Formen und die Dimension von Räumen visuell wahrnehmbar, der richtige Umgang mit Licht ist entscheidend für die Wirkung des Raumes. Zudem ist Licht wie kein anderes visuelles Medium in der Lage Emotionen zu beeinflussen.

Moree konzentriert sich auf innovative LED-Technologie in Symbiose mit seinen Produkten. Die LED-Module werden mittels Fernbedienung gesteuert und ermöglichen unzählige Farben, Helligkeiten und vielfältige Effekte auf Knopfdruck. Licht und Farbe eröffnen neue Gestaltungsdimensionen im Design und machen die Faszination der Moree-Produkte aus.

EN Only through light can colours, materials, shapes and spaces be visually perceived, and light, like no other medium can influence your emotions in any situation. The correct handling of light is crucial for the effect in any environment.

Moree focuses on innovative LED technology in symbiosis with its products. The LED modules are remote controlled which enable endless colours, brightness and a variety of effects right at your fingertips. Light and colour are what make Moree products so intriguing, and open up new dimensions in our designs - enhancing ambience.

FR Seule la lumière donne une âme aux couleurs, matériaux, formes et dimensions des intérieurs. Les effets qu'un intérieur peut produire dépendent largement de la gestion adéquate de la lumière. Et il ne faut pas oublier que la lumière n'a pas sa pareille parmi les médias visuels s'il s'agit d'influencer les émotions.

Moree se concentre sur la technologie DEL innovante en une symbiose parfaite avec ses produits. Les modules DEL sont télécommandables, d'innombrables couleurs, luminosités et effets variés peuvent ainsi être créés sur une simple pression de touche. La lumière et les couleurs ouvrent des horizons nouveaux au design et rendent les produits de Moree si fascinants.

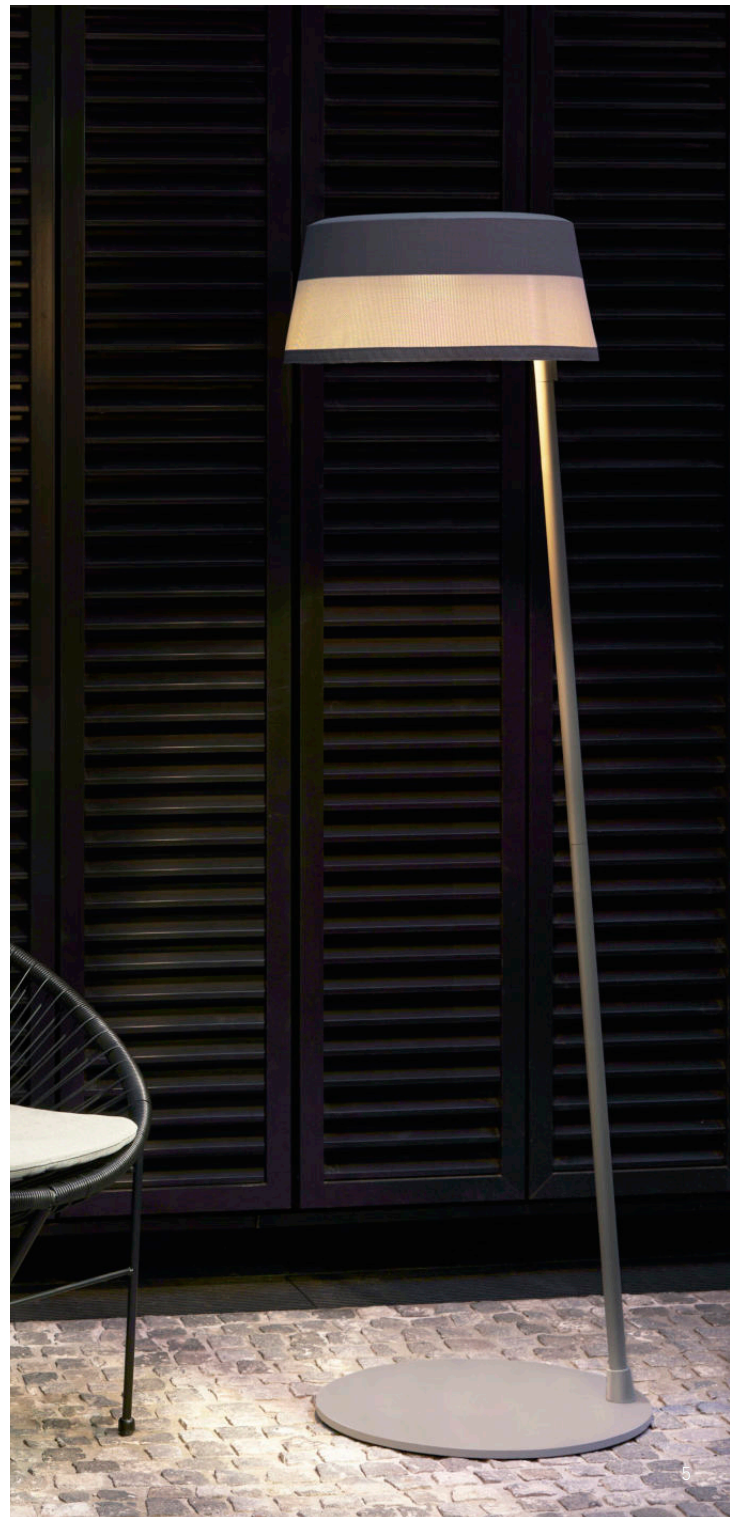

02

ÜBER MOREE
ABOUT MOREE
À PROPOS DE MOREE

04

MATERIALIEN & LICHT
MATERIAL & LIGHT
MATÉRIEL ET LUMIÈRE

08

LOUNGE MÖBEL
LOUNGE FURNITURE
LOUNGE MEUBLES



NEW

8|74
AIR COLLECTION



NEW

8|76
AIR BARSTOOL

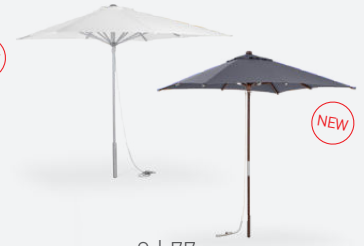

NEW

8|77
PARASOL

24

ILLUMINIERTER MÖBEL
ILLUMINATED FURNITURE
MEUBLES ILLUMINÉS



26|94
ORA HOME

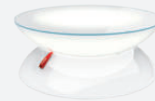

28|96
LOUNGE | VARIATION



32|100
LOUNGE 45|55|75|105

40

LEUCHTEN
LIGHTING
LUMIÈRES



NEW

42|109
ARNOLD S



44|110
EMILY M|L



46|111
LOUIS



48|112
SPOTE



NEW

50|113
ARNOLD XL

62

MODULARES LED BAR SYSTEM
MODULAR LED BAR SYSTEM
SYSTÈME DE BARRE À DEL MODULAIRE

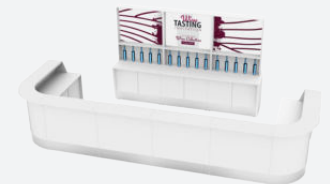

64|126
LED BARS



10|75 & 12|80
ED TABLE | ED



16|75
ED 105 TABLE WHITE/ANTHRACITE



18|82
ED BARSTOOL



22|86
DAVE



34|102
STUDIO



36|104
CUBE



38|91
BUBBLE



40|106
COOLER



52|114
ISA-BELLE



54|115
SWAP 150



56|118
ALICE XL



58|120
SHARK



60|122
STARS



62|124
9 W CCT | 11 W CCT

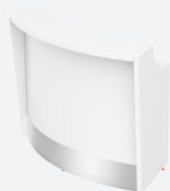

68|126
LED COUNTERS

72
PROJEKTE
PROJECTS
PROJETS

74
TECHNISCHE DATEN
TECHNICAL DATA
CARACTÉRISTIQUES
TECHNIQUES



Mod. 45-01-0X
Weiß
White
Blanc

NEW AIR-COLLECTION



Mod. 45-02-0X
Anthrazit
Anthracite
Anthracite

- Schirmhalter für Sonnen- und Regenschutz
- outdoortauglich, aus Aluminium
- hochwertig, dadurch sehr nachhaltig
- modular

- Umbrella holder for sun and rain protection
- suitable for outdoor use, made of aluminium
- high quality, highly sustainable
- modular

- Porte-parapluie pour la protection contre le soleil et la pluie
- adaptée à l'extérieur, en aluminium
- de haute qualité, donc très durable
- modulaire



Mod. 45-03-0X
Anthrazit/Holz
Anthracite/Wood
Anthracite/Bois

ED 45 | 75 | 105

- Tisch mit robuster HPL-Tischplatte
- Perfekte Kombination mit ED Barhocker

- Table with robust HPL table top
- Perfect combination with ED barstool

- Table avec plateau HPL robuste
- Combinaison parfaite avec le tabouret ED

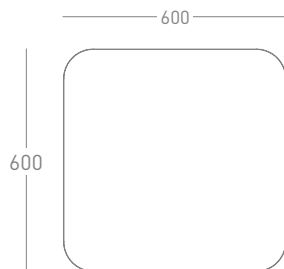

ED 45 | 600 x 600 x H450



ED 75 | 600 x 600 x H750



ED 105 | 600 x 600 x H1050

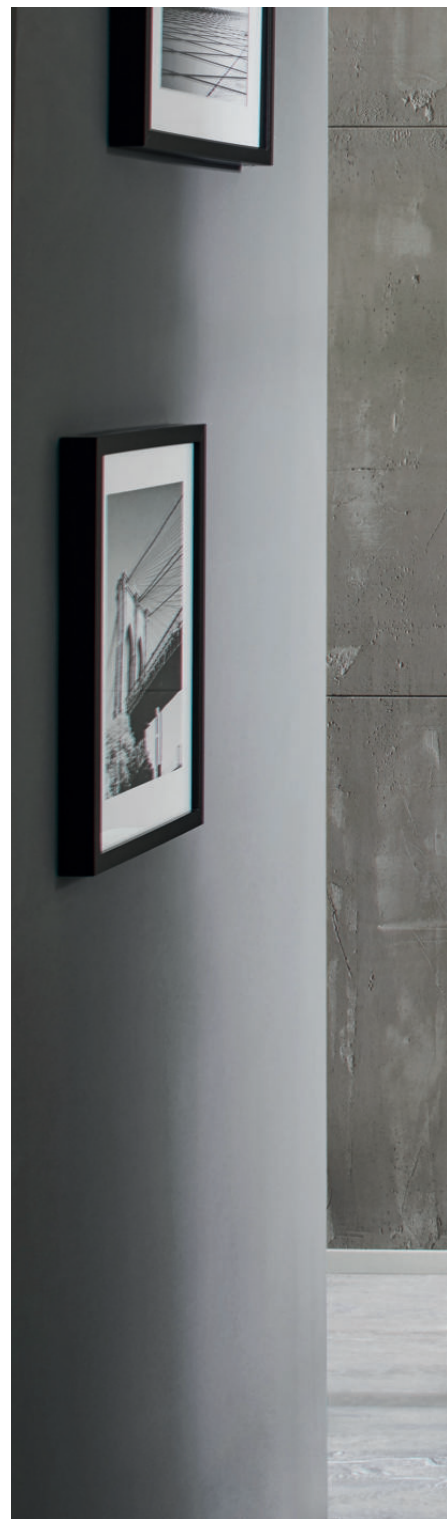





GESTELL IN WEISS MIT EDELSTAHL

- Sitzfläche in Weiß, Eiche oder Walnuss
- Höhenverstellbar
- Im Sitz integrierter Stellhebel
- 360° Rotation des Sitzes

FRAME IN WHITE WITH STAINLESS STEEL

- Seat in white, oak or walnut
- Height adjustable
- Adjustment lever integrated in the seat
- 360° rotation of the seat

STRUCTURE EN BLANC AVEC ACIER INOXYDABLE

- Assise en blanc, chêne ou noyer
- Réglable en hauteur
- Levier de réglage intégré dans le siège
- Rotation de l'assise à 360°

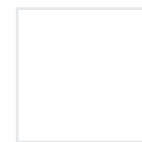
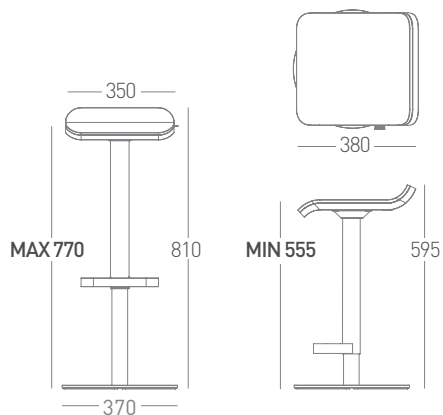

Weiß/
White/
Blanc

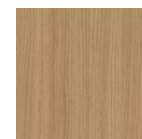

Eiche/
Oak/
Chêne



Walnuss/
Walnut/
Noyer



ED ADJUSTABLE
White-White | Mod. 13-02-03



ED ADJUSTABLE
White-Oak | Mod. 13-02-31



ED ADJUSTABLE
White-Walnut | Mod. 13-02-32



ED ANTHRACITE

GESTELL IN ANTHRACIT MIT EDELSTAHL

- Sitzfläche in Weiß, Eiche oder Walnuss
- Höhenverstellbar
- Im Sitz integrierter Stellhebel
- 360° Rotation des Sitzes

FRAME IN ANTHRACITE WITH STAINLESS STEEL

- Seat in white, oak or walnut
- Height adjustable
- Adjustment lever integrated in the seat
- 360° rotation of the seat

STRUCTURE EN ANTHRACITE AVEC ACIER INOXYDABLE

- Assise en blanc, chêne ou noyer
- Réglable en hauteur
- Levier de réglage intégré dans le siège
- Rotation de l'assise à 360°

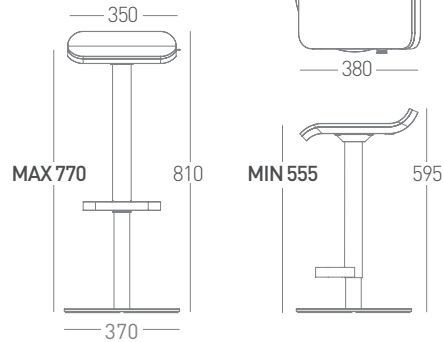

Weiß/
White/
Blanc



Anthrazit/
Anthracite/
Anthracite

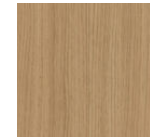

Eiche/
Oak/
Chêne

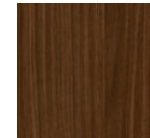

Walnuss/
Walnut/
Noyer



ED ADJUSTABLE
Anthracite-White | Mod. 13-02-01



ED ADJUSTABLE
Anthracite-Oak | Mod. 13-02-11



ED ADJUSTABLE
Anthracite-Walnut | Mod. 13-02-12

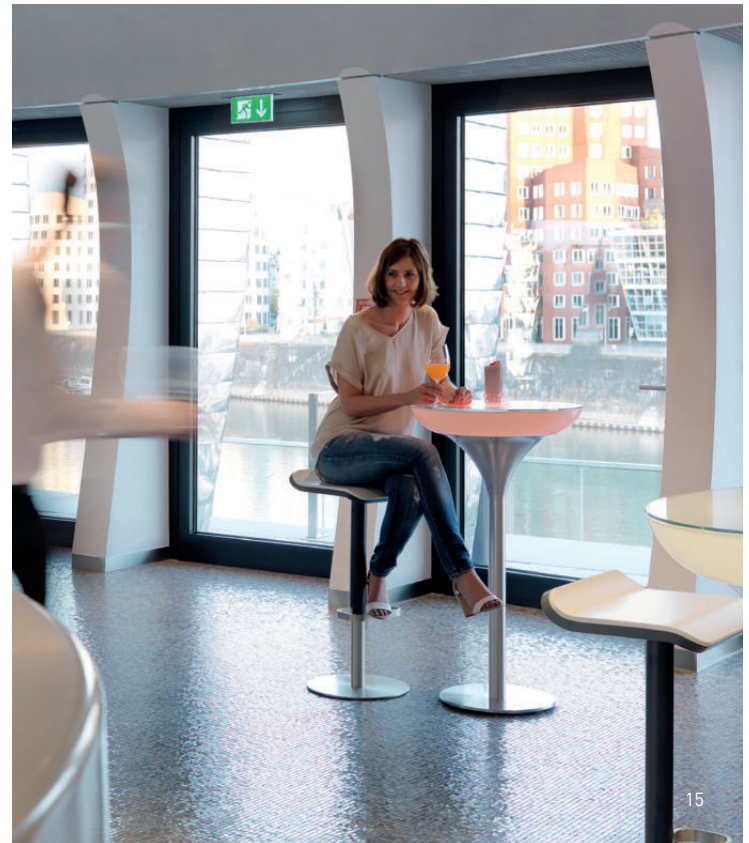

ED 105 WHITE | ED 105 ANTHRACITE

- Tisch mit robuster HPL-Tischplatte
- Perfekte Kombination mit ED oder DAVE Barhocker
- Table with robust HPL table top
- Perfect combination with ED or DAVE barstool
- Table avec plateau HPL robuste
- Combinaison parfaite avec le tabouret ED ou DAVE

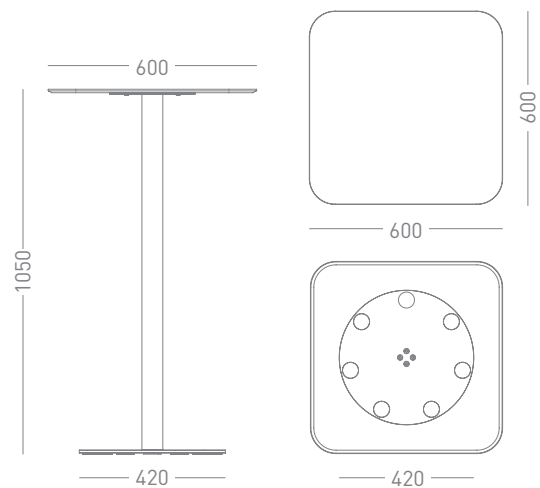

ED 105 WHITE
Mod. 18-05-105

NEW



ED 105 ANTHRACITE
Mod. 18-06-105

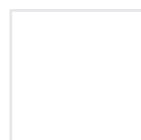

Weiß/
White/
Blanc



Anthrazit/
Anthracite/
Anthracite





GESTELL STATISCH ODER HÖHENVERSTELLBAR

- Sitz & Gestell in Weiß
- Sitzfläche in Weiß, Eiche oder Walnuss



Weiß/
White/
Blanc



Eiche/
Oak/
Chêne



Walnuss/
Walnut/
Noyer



ED STATIC
White White Mod.13-01-03



ED STATIC
White Oak Mod.13-01-31



ED STATIC
White Walnut Mod.13-01-32

FRAME STATIC OR ADJUSTABLE

- Seat & frame in white
- Seat in white, oak or walnut

SUPPORT STATIQUE OU RÉGLABLE EN HAUTEUR

- Assise & piètement en blanc
- Assise en blanc, chêne ou noyer

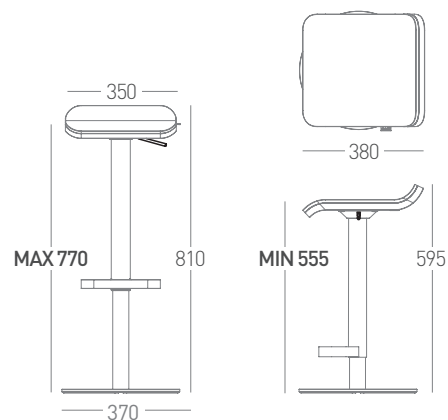
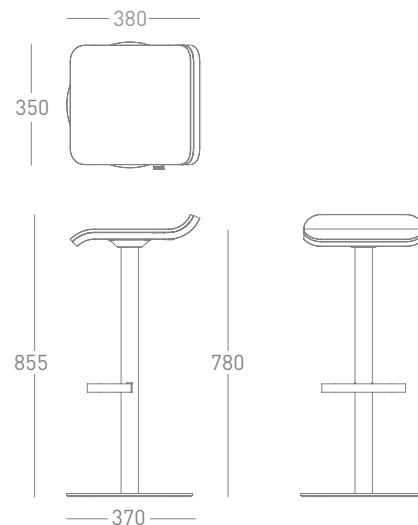

ED ADJUSTABLE
White White Mod.13-03-03



ED ADJUSTABLE
White Oak Mod.13-03-31



ED ADJUSTABLE
White Walnut Mod.13-03-32



ED ANTHRACITE

GESTELL STATISCH ODER HÖHENVERSTELLBAR

- Sitz & Gestell in Anthrazit
- Sitzfläche in Weiß, Eiche oder Walnuss



Weiß/
White/
Blanc



Anthrazit/
Anthracite/
Anthracite



Eiche/
Oak/
Chêne



Walnuss/
Walnut/
Noyer



ED STATIC
Anthracite White Mod.13-01-01



ED STATIC
Anthracite Oak Mod.13-01-11



ED STATIC
Anthracite Walnut Mod.13-01-12

FRAME STATIC OR ADJUSTABLE

- Seat & frame in anthracite
- Seat in white, oak or walnut

SUPPORT STATIQUE OU RÉGLABLE EN HAUTEUR

- Assise & piètement en anthracite
- Assise en blanc, chêne ou noyer

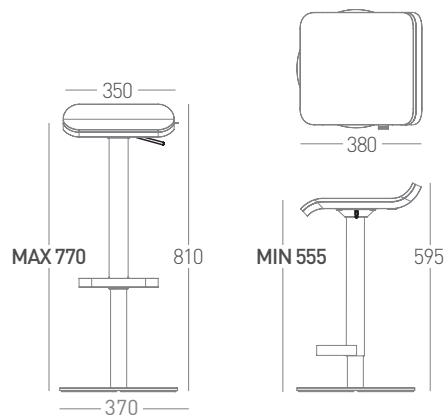
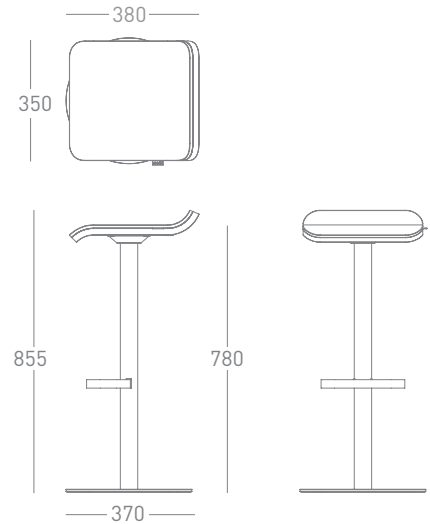

ED ADJUSTABLE
Anthracite White Mod.13-03-01



ED ADJUSTABLE
Anthracite Oak Mod.13-03-11



ED ADJUSTABLE
Anthracite Walnut Mod.13-03-12

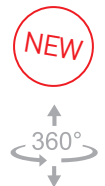





DAVE WHITE

BY DAVID STUTTARD

GESTELL STATISCH ODER HÖHENVERSTELLBAR

- Gestell in Weiß
- Sitz in 50 Farben erhältlich (siehe S. 86)

FRAME STATIC OR ADJUSTABLE

- Frame in white
- Seat available in 50 colours (see p. 86)

SUPPORT STATIQUE OU RÉGLABLE EN HAUTEUR

- Piètement en blanc
- Siège disponible en 50 couleurs (voir P. 86)



DAVE STATIC
White/Light Grey
Mod. 42-01-01



DAVE STATIC
White/Anthracite
Mod. 42-01-02



DAVE STATIC
White/Sage
Mod. 42-01-03



DAVE STATIC
White/Wine Red
Mod. 42-01-04

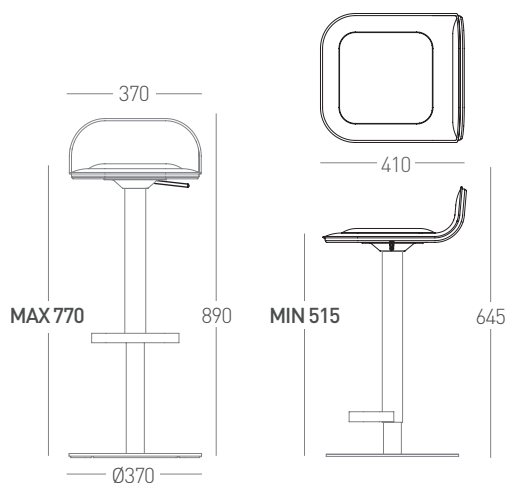
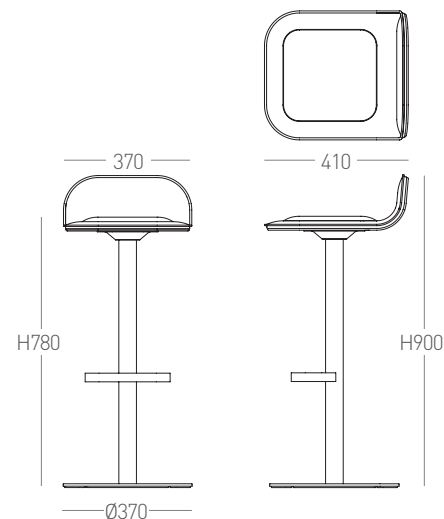

DAVE ADJUSTABLE
White/Light Grey
Mod. 42-03-01



DAVE ADJUSTABLE
White/Anthracite
Mod. 42-03-02



DAVE ADJUSTABLE
White/Sage
Mod. 42-03-03



DAVE ADJUSTABLE
White/Wine Red
Mod. 42-03-04

NEW

360°

DAVE ANTHRACITE

BY DAVID STUTTARD

GESTELL STATISCH ODER HÖHENVERSTELLBAR

- Gestell in Anthrazit
- Sitz in 50 Farben erhältlich (siehe S. 86)

FRAME STATIC OR ADJUSTABLE

- Frame in anthracite
- Seat available in 50 colours (see p. 86)

SUPPORT STATIQUE OU RÉGLABLE EN HAUTEUR

- Piètement en anthracite
- Siège disponible en 50 couleurs (voir P. 86)



DAVE STATIC
Anthracite/Light Grey
Mod. 42-02-01



DAVE STATIC
Anthracite/Anthracite
Mod. 42-02-02



DAVE STATIC
Anthracite/Sage
Mod. 42-02-03



DAVE STATIC
Anthracite/Wine Red
Mod. 42-02-04

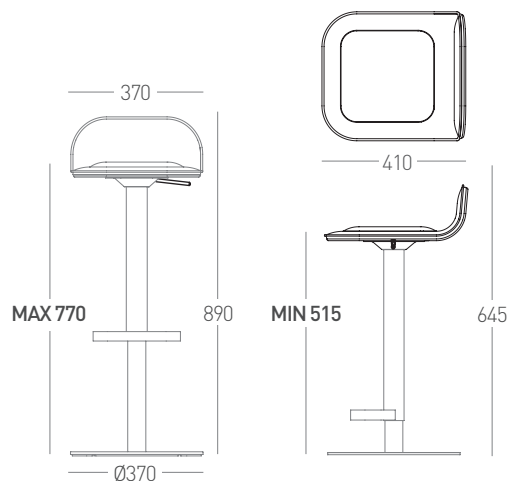
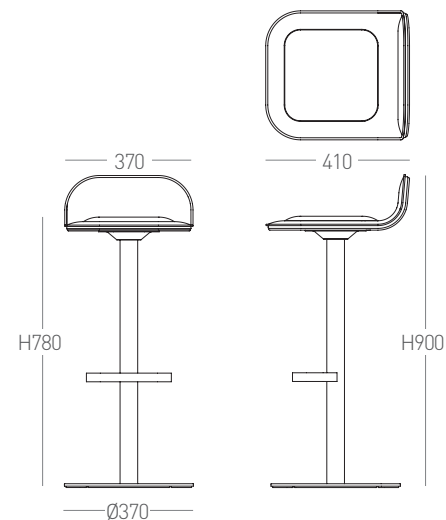

DAVE ADJUSTABLE
Anthracite/Light Grey
Mod. 42-04-01



DAVE ADJUSTABLE
Anthracite/Anthracite
Mod. 42-04-02



DAVE ADJUSTABLE
Anthracite/Sage
Mod. 42-04-03



DAVE ADJUSTABLE
Anthracite/Wine Red
Mod. 42-04-04





Stoffbezug aus 98%
recyceltem Material
Fabric cover made from
98% recycled material
Housse en tissu à 98% de
matières recyclées

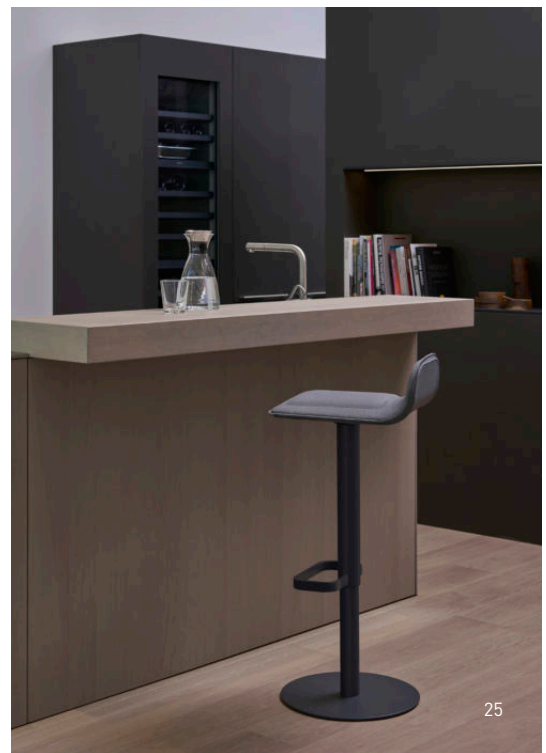



- LED-Beleuchtung RGB/Warmweiß
- Version mit Zuleitung (Mod. 28-16-01)
- Version mit Akku (kabellos) (Mod. 28-26-01)
- Mit stylischem Stauraum
- Auch ohne Beleuchtung erhältlich

- LED lighting RGB/Warm white
- Version with supply cable (Mod. 28-16-01)
- or cordless with rechargeable battery (Mod. 28-26-01)
- Stylish Storage Space
- Also available without light

- Éclairage LED RGB/Blanc chaud
- Version avec câble d'alimentation (Mod. 28-16-01)
- ou sans fil avec batterie rechargeable (Mod. 28-26-01)
- Espace de stockage élégant
- Également disponible sans lumière

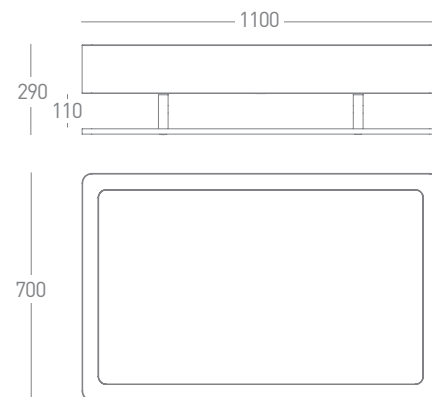

Ora Home LED Pro
Mod. 28-16-01

LOUNGE

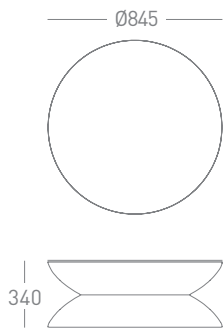

- Beleuchteter Tisch
- Mit Akku oder 230 V Zuleitung
- Für Innenbereich oder Außenbereich
- Inklusive Glasplatte

- Illuminated table
- With rechargeable battery or 230 V supply line
- For indoor or outdoor use
- Including glass top

- Table éclairés
- Avec batterie ou câble d'alimentation 230 V
- Pour l'intérieur ou l'extérieur
- Y compris: plaque de verre





LOUNGE VARIATION

- Wandleuchte oder beleuchteter Loungetisch
- Mit Akku oder 230 V Zuleitung
- Für Innenbereich oder Außenbereich
- Inklusive Glasplatte
- Wall light or illuminated lounge table
- With rechargeable battery or 230 V supply line
- For indoor or outdoor use
- Including glass top
- Applique murale ou table de salon éclairée
- Avec batterie ou câble d'alimentation 230 V
- Pour l'intérieur ou l'extérieur
- Y compris: plaque de verre

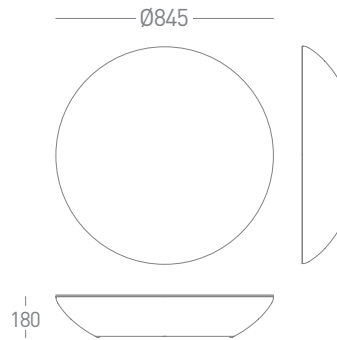



LOUNGE 45 | 55 | 75 | 105

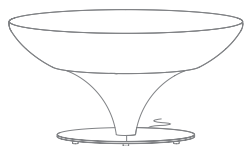

45 | Ø 845 x H450

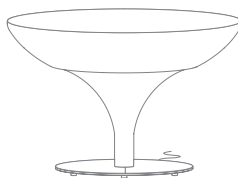

55 | Ø 845 x H550



75 | Ø 845 x H750

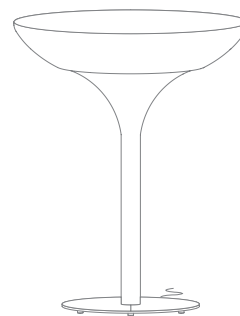

105 | Ø 845 x H1050





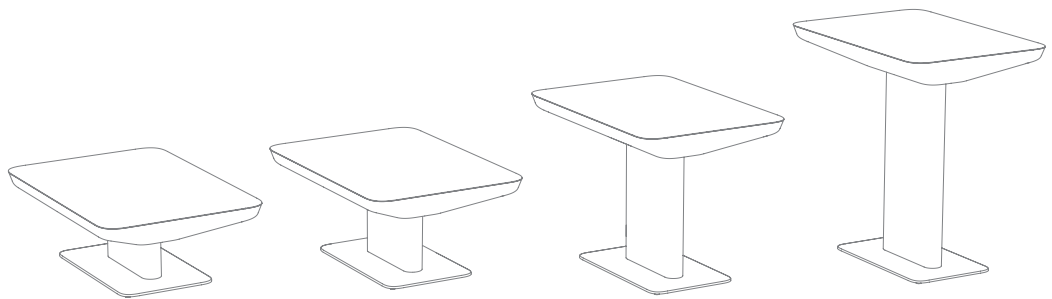

36 | 700 x 1000 x H360

45 | 700 x 1000 x H450

75 | 700 x 1000 x H750

105 | 700 x 1000 x H1050

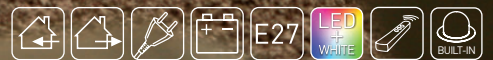



- Innovatives Sitzmöbel und Tisch
- Dekoratives Leuchtobjekt
- Mit Akku oder 230 V Zuleitung
- Für Innenbereich oder Außenbereich
- Zubehör optional: Glasplatte oder Kissen

- Innovative seat and table
- Decorative illuminant
- With rechargeable battery or 230 V supply line
- For indoor or outdoor use
- Optional accessory: glass top or cushion

- Siège et table innovants
- Illuminant décoratif
- Avec batterie ou câble d'alimentation 230 V
- Pour l'intérieur ou l'extérieur
- Accessoires optionnels: plaque de verre ou coussin



BUBBLE

- Beleuchteter Sitz & Tisch
- Dekoratives Leuchtoobjekt
- Mit Akku oder 230 V Zuleitung
- Für Innenbereich oder Außenbereich
- Inklusive Glasplatte oder Kissen

- Illuminated seat & table
- Decorative illuminant
- With rechargeable battery or 230 V supply line
- For indoor or outdoor use
- Including glass top or cushion

- Siège et table éclairés
- Illuminant décoratif
- Avec batterie ou câble d'alimentation 230 V
- Pour l'intérieur ou l'extérieur
- Y compris: plaque de verre ou coussin

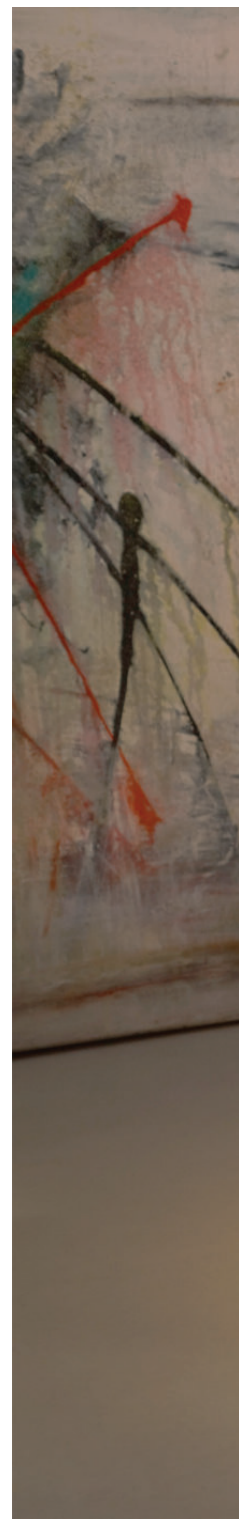
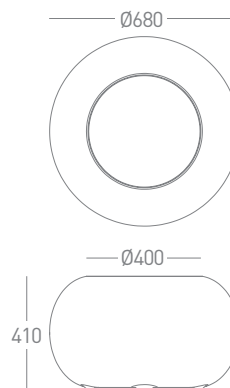



COOLER 70 & COOLER 89

- Für Indoor- und Outdoor Anwendungen
- Ideal für Home & Contract
- Multicolour LED-Einheit mit aufladbarem Akku
- Mit IR-Fernbedienung
- Leicht wechselbare, wiederaufladbare LED-Einheit (1)
- LED-Einheit mit Schnellwechsel-Magnetverschluss
- herausnehmbar Getränke-Einsatz (Cooler 70)

- For indoor and outdoor use
- Ideal for Home & Contract
- Multicolour LED unit with rechargeable battery
- With IR remote control
- Easily exchangeable & rechargeable LED unit (1)
- LED unit with quick-change magnetic lock
- Removable beverage insert (Cooler 70)

- Pour une utilisation intérieure et extérieure
- Idéal pour la maison et le contrat
- Unité LED multicolore avec batterie rechargeable
- Avec télécommande IR
- Unité LED (1) facilement remplaçable et rechargeable
- Unité LED avec serrure magnétique à changement rapide
- Insert à boissons amovible [Cooler 70]





moree | ILLUMINIERTE MÖBEL



- Verwendung Indoor & Outdoor
 - Kabellos, mit wiederaufladbarem Li-Ion Akku
 - Aufladen per Ladestation mit USB-Netzteil
 - LED-Farbe in 2700 oder 3000 K einstellbar
 - Mit Ladekontrollleuchte
 - Stufenlos dimmbar
-
- Indoor & outdoor use
 - Cordless, with rechargeable Li-Ion battery
 - Charging on charging station via USB power supply unit
 - LED colour adjustable in 2700 or 3000 K
 - With charging indicator light
 - Continuously dimmable
-
- Utilisation intérieure et extérieure
 - Sans fil, avec batterie Li-Ion rechargeable
 - Recharge sur la station de chargement par adaptateur secteur USB
 - Couleur de la LED réglable en 2700 ou 3000 K
 - Avec indicateur de charge
 - Gradation en continu

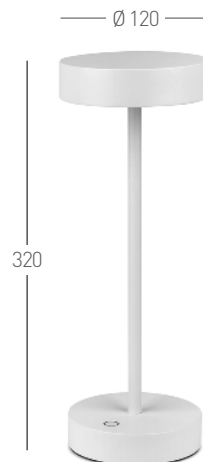

MOD. 47-01-32



MOD. 47-02-32



Ladestation
Charging Station
Station de chargement



Laden auf Ladestation
Charging on Station
Charge sur la station de charge



EMILY M | EMILY L

- Verwendung Indoor & Outdoor
- Kabellos, mit wiederaufladbarem Li-Ion Akku
- Aufladen per Ladestation mit USB-Netzteil
- Mit Ladekontrollleuchte
- Stufenlos dimmbar

- Indoor & outdoor use
- Cordless, with rechargeable Li-Ion battery
- Charging on charging station via USB power supply unit
- With charging indicator light
- Continuously dimmable

- Utilisation intérieure et extérieure
- Sans fil, avec batterie Li-Ion rechargeable
- Recharge sur la station de chargement par adaptateur secteur USB
- Avec indicateur de charge
- Gradation en continu



EMILY M | 46-01-38

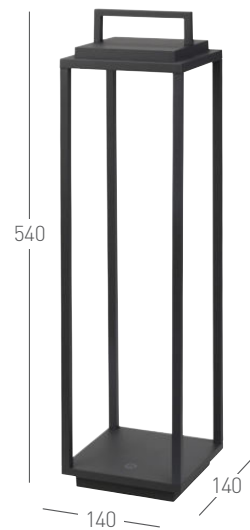

EMILY L | 46-01-54



Ladestation
Charging Station
Station de chargement



Laden auf Ladestation
Charging on Station
Charge sur la station de charge



moree | LEUCITEN



LOUIS | SOLAR LANTERN

>DUALES AUFLADEN<

DURCH SOLARMODUL ODER LADEGERÄT

- Verwendung Indoor- und Outdoor
- Aluminium pulverbeschichtet für den Aussenbereich
- Wiederaufladbarer Li-Ion Akku
- Mit Ladekontrollleuchte
- Warmweisse LEDs (3000K/238lm)
- Betriebszeit ca. 9 Std.
- LEDs dimmbar

>DUAL CHARGING<

BY SOLAR MODULE OR ADAPTER

- Use indoor and outdoor
- Powder-coated aluminium for outdoor use
- Rechargeable Li-ion battery
- With charge indicator light
- Warm white LEDs (3000K/238lm)
- Operating time approx. 9 hours
- LEDs dimmable

>DOUBLE CHARGE<

PAR MODULE SOLAIRE OU CHARGEUR

- Utiliser à l'intérieur et à l'extérieur
- Aluminium enduit de poudre pour usage extérieur
- Batterie Li-ion rechargeable
- Avec voyant de charge
- LED blanc chaud (3000K/238lm)
- Durée de fonctionnement env. 9 h
- DEL dimmable





SPOTE | SOLAR SPOT

- Aufladen per Solarpanel
- Beleuchteter Ein-/Aus Schalter
- Automatisches Ein-/Ausschalten durch Helligkeitssensor bei 20-30 Lux
- schwenkbarer Lampenkopf
- Befestigung per Erdspieß oder M6 Schraube auf Unterseite

- Charging via solar panel
- Illuminated ON/OFF switch
- Automatic ON/OFF by brightness sensor at 20-30 lux
- Swivel lamp head
- Mounting by ground spike or M6 screw on underside

- Chargement par panneau solaire
- Interrupteur marche/arrêt éclairé
- Mise en marche/arrêt automatique par capteur de luminosité à 20-30 lux
- Tête de lampe pivotante
- Fixation par piquet de terre ou vis M6 sur la face inférieure





ARNOLD XL NEW

- Verwendung Indoor & Outdoor
- Kabellos, mit wiederaufladbarem Li-Ion Akku
- Aufladen per USB-Netzteil
- LED-Farbe in 3000 K
- Mit Ladekontroll-Leuchte
- EIN/AUS-Berührungsschalter
- Stufenlos dimmbar

- Indoor & outdoor use
- Cordless, with rechargeable Li-Ion battery
- Charging via USB power supply unit
- LED colour in 3000 K
- With charging indicator light
- ON/OFF touch switch
- Continuously dimmable

- Utilisation intérieure et extérieure
- Sans fil, avec batterie Li-Ion rechargeable
- Recharge par adaptateur secteur USB
- Couleur de la DEL en 3000 K
- Avec indicateur de charge
- Interrupteur tactile ON/OFF
- Gradation en continu



MOD. 47-01-138

MOD. 47-02-138





ISABELLE | SOLAR FLOOR & ARC LAMP (2IN1) NEW

MOD. 44-01-01

>2IN1 FUNKTION<

- Solar-Stehleuchte & Bogenleuchte in Einem
- Verwendung Indoor- und Outdoor
- Wiederaufladbarer Li-Ion Akku
- Laden per Solarpanel oder Adapter
- Warmweisse LEDs (3000 K/800 lm)
- LEDs dimmbar
- Betriebszeit 8-20 Std

>2IN1 FUNCTIONS<

- Solar floor lamp & arc lamp in one
- Use indoor and outdoor
- Rechargeable Li-Ion battery
- Charging via solar panel or adapter
- Warm white LEDs (3000 K/800 lm)
- LEDs dimmable
- Operating time 8-20 hours

>1EN1 FONCTION<

- Lampe à pied solaire et lampe à arc en un
- Utiliser à l'intérieur et à l'extérieur
- Batterie Li-Ion rechargeable
- Chargement par panneau solaire ou adaptateur
- LED blanc chaud (3000 K/800 lm)
- DEL à intensité variable
- Durée de fonctionnement 8-20 heures





SWAP 150

- Outdoor- und Indoorleuchte
- Standard-Leuchte mit weiß-transluzentem PE-Schirm (ohne Designschirm-Aufsatz)
- Zubehör: wechselbare Design-Schirme
- Oder Gewebeschirm, grau

- Indoor & outdoor lamp
- Standard lamp with white translucent PE shade (without design shade cover)
- Accessories: swappable design shades
- Or with grey fabric shade

- Lampe intérieure et extérieure
- Luminaire standard avec abat-jour PE blanc translucide (sans des abat-jour design couverture)
- Accessoires: des abat-jours design interchangeableables
- Ou avec abat-jour en tissu, gris



31-01-150

31-02-150

31-03-150

31-04-150

31-05-150

31-06-150

31-00-150



MOD. 31-06-01
Grauer Gewebeschirm-Aufsatz
MOD. 31-06-01
Grey fabric shade cover
MOD. 31-06-01
Abat-jour en tissu, gris



ALICE XL

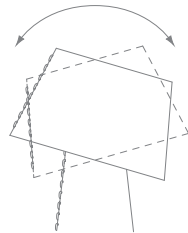
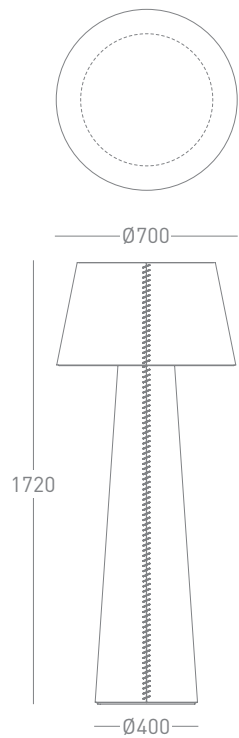

- Mit schwenkbarem Schirm
- With tiltable head
- Avec tête inclinable







- Dekoratives Leuchtobjekt
- Mit Akku oder 230 V Zuleitung
- Für Innenbereich oder Außenbereich
- Decorative illuminant
- With rechargeable battery or 230 V supply line
- For indoor or outdoor use
- Illuminant décoratif
- Avec batterie ou câble d'alimentation 230 V
- Pour l'intérieur ou l'extérieur

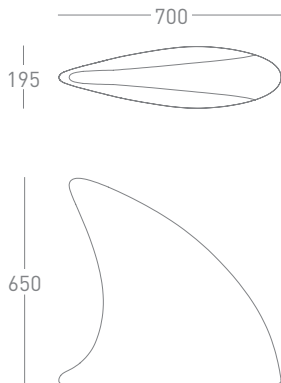

STAR 40 | STAR 60

- Stern in 2 Größen für Innen & Aussen
 - Multicolor LED-Einheit mit Fernbedienung
 - Version mit Ladegerät & Akku für kabellosen Betrieb
 - und Version mit 230 V Outdoorkabel erhältlich
 - Integrierte Wandaufhängung
 - Erdspieß zur Bodenbefestigung
-
- Star in 2 sizes for inside & outside
 - Multicolour LED unit with remote control
 - Version with charger and battery for wireless operation
 - and 230 V outdoor cable version available
 - Integrated wall suspension
 - Ground spike for ground mounting
-
- Étoile en 2 tailles pour l'intérieur et l'extérieur
 - Unité LED multicolore avec télécommande
 - Inclus chargeur et batterie pour le fonctionnement sans fil
 - Autre version de câble extérieure 230 V disponible
 - Suspension murale intégrée
 - Pointe au sol pour montage au sol

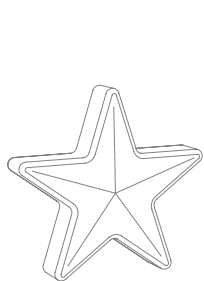

STAR 40 | 410 x 100 x H 400

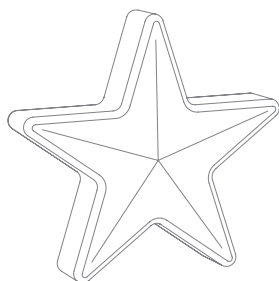

STAR 60 | 570 x 130 x H 550

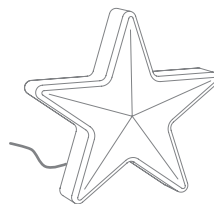

STAR 40 | 410 x 100 x H 400

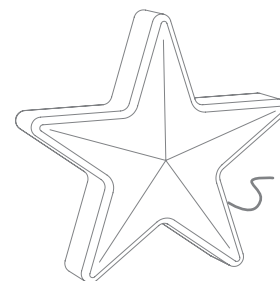

STAR 60 | 570 x 130 x H 550



11W E27 RGB CCT WIFI BULB

FUNKTIONEN

- Steuerung per MOREE REMOTE APP
- Kompatibel mit Google Assistant und Amazon Echo über Sprachsteuerung
- Szenen- und Farbprogramme
- Farben: RGB-Spektrum + CCT
- Licht von Warm- bis Kaltweiß einstellbar
- Eingebautes WLAN-Modul
- Zeitschalter per App
- Dimm-Funktion per App

FUNCTIONS

- Control via MOREE REMOTE APP
- Works with Google Assistant & compatible with Amazon Alexa
- Scene and colour programmes
- Colours: RGB Spectrum + CCT
- Warm to cold white adjustable
- Built in wifi controller
- Timing switch via app
- Dimming function via App

FONCTIONS

- Contrôle via MOREE REMOTE APP
- Compatible avec Google Assistant et Amazon Alexa via contrôle vocal
- Programmes de scènes et de couleurs
- Couleurs: RGB Spectrum + CCT
- Chaud à blanc froid réglable
- Module WIFI intégré
- Interrupteur de synchronisation via l'application
- Fonction de variation via l'app



Mod. 20-03-01



MOREE MOBILE
REMOTE APP

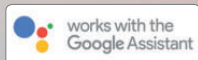

9W E27 RGB CCT BULB

FUNKTIONEN

- Steuerbar mit Fernbedienung (Mod. 20-02-02)
- 9 Programme
- Dimmbar mit Fernbedienung
- Das gesamte RGB-Spektrum, Farbsättigung ist einstellbar
- Warm- bis kaltweißes Licht stufenlos einstellbar: 2700 – 6500 K
- 4-Kanal-Steuerung
- Reichweite bis zu 30 m

FUNCTIONS

- Controllable with radio remote control (Mod. 20-02-02)
- 9 programmes
- The entire RGB spectrum, colour saturation is customisable
- Warm to cool white light is adjustable: 2700 – 6500 K
- Dimmable (with remote control)
- 4-channel control
- Range up to 30 m (radio)

FONCTIONS

- Contrôlable par télécommande radio (Mod. 20-02-02)
- 9 programmes
- Tout le spectre RGB, la saturation des couleurs est réglable
- Lumière blanche chaude à froide est réglable: 2700 – 6500 K
- Gradable (avec télécommande)
- Commande à 4 canaux
- Portée jusqu'à 30 m (radio)



Mod. 20-02-02



Mod. 20-04-01



MODULAR BAR

- Umfangreiche Auswahl an Modulen
 - Alle Theken-Module kombinierbar
 - Duale Front- und Rückbeleuchtung individuell steuerbar
 - Umfangreiche Farb-, Material- & Zubehörauswahl
-
- Extensive range of modular elements available
 - All Bar modules combinable
 - Dual front and back lighting individually controllable
 - Extensive choice of colors, materials & accessories
-
- Grosse gamme de modules disponibles
 - Tous les modules de bar combinables
 - Double éclairage avant et arrière individuellement contrôlable
 - Large choix de couleurs, matériaux et accessoires

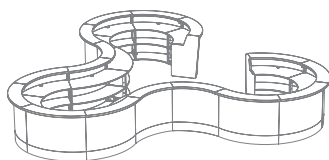
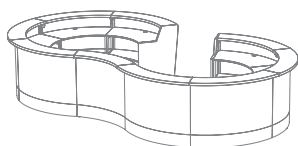
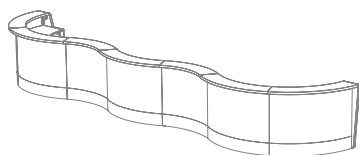

Mehr Informationen in unsrerem Thekenkatalog online
Please read our bar catalogue online
Plus d'informations dans le catalogue en ligne
www.moree.de/moree-bar-catalogue/

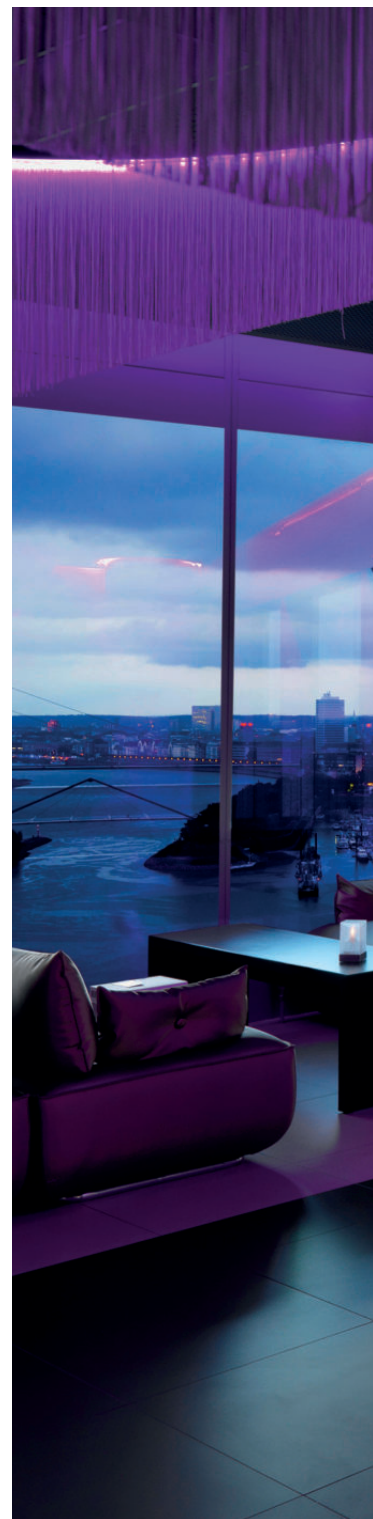



moree | MODULARES LED BAR SYSTEM





MODULAR BAR

- Umfangreiche Auswahl an Modulen
 - Alle Theken-Module kombinierbar
 - Duale Front- und Rückbeleuchtung individuell steuerbar
 - Umfangreiche Farb-, Material- & Zubehörauswahl
-
- Extensive range of modular elements available
 - All Bar modules combinable
 - Dual front and back lighting individually controllable
 - Extensive choice of colors, materials & accessories
-
- Grosse gamme de modules disponibles
 - Tous les modules de bar combinables
 - Double éclairage avant et arrière individuellement contrôlable
 - Large choix de couleurs, matériaux et accessoires

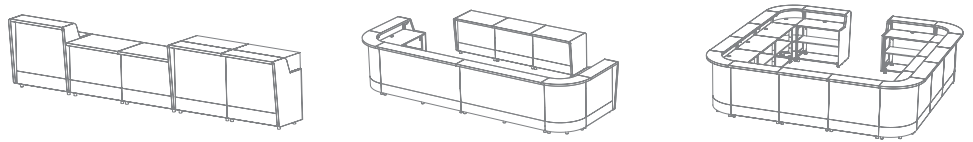

Mehr Informationen in unserem Thekenkatalog online
Please read our bar catalogue online
Plus d'informations dans le catalogue en ligne
www.moree.de/moree-bar-catalogue/



1M COUNTER

- 2 Versionen erhältlich: RADIUS & EDGE
 - Duale Front- und Rückbeleuchtung individuell steuerbar
 - Umfangreiche Farb-, Material- & Zubehörauswahl
 - Komplett montiert inkl. Endstücken, nicht-modular
- 2 versions available: RADIUS & EDGE
 - Dual front and back lighting individually controllable
 - Extensive choice of colors, materials & accessories
 - Fully assembled, non-modular
- 2 versions disponibles: RADIUS & EDGE
 - Double éclairage avant et arrière individuellement contrôlable
 - Large choix de couleurs, matériaux et accessoires
 - Entièrement assemblé, non modulaire

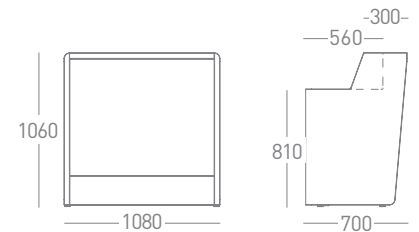

60° COUNTER

- 2 Versionen erhältlich: RADIUS & EDGE
- Duale Front- und Rückbeleuchtung individuell steuerbar
- Umfangreiche Farb-, Material- & Zubehörauswahl
- Komplett montiert inkl. Endstücken, nicht-modular

- 2 versions available: RADIUS & EDGE
- Dual front and back lighting individually controllable
- Extensive choice of colors, materials & accessories
- Fully assembled, non-modular

- 2 versions disponibles: RADIUS & EDGE
- Double éclairage avant et arrière individuellement contrôlable
- Large choix de couleurs, matériaux et accessoires
- Entièrement assemblé, non modulaire

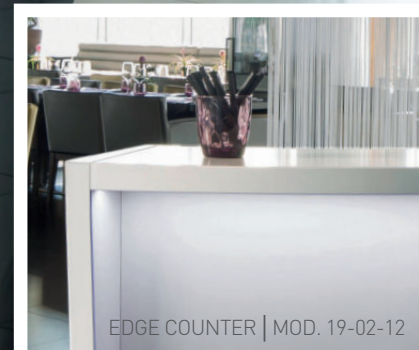
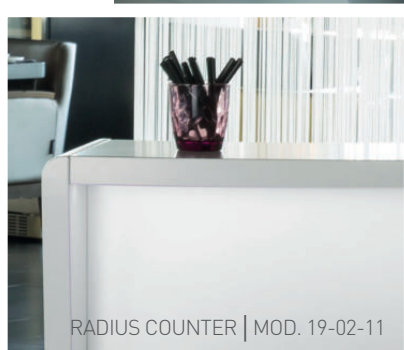
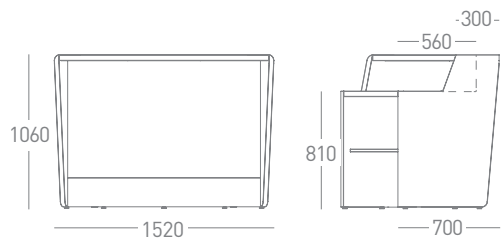



PROJEKTE

PROJECTS | PROJETS



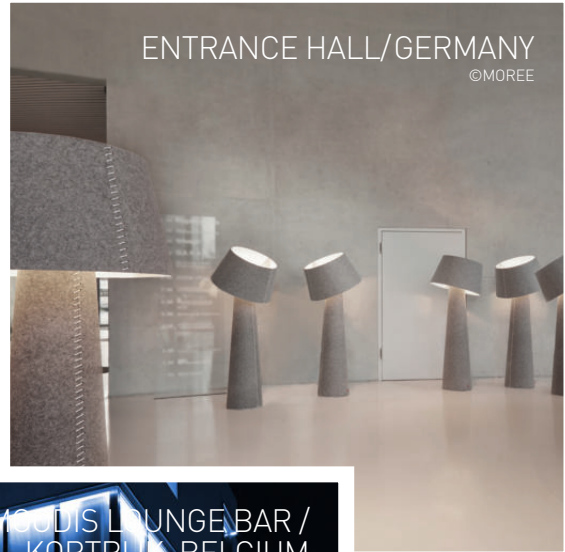

Mehr Informationen online | Please read online | Plus d'informations en ligne
www.moree.de/en/projects/



LOUNGE MÖBEL - TECHNISCHE DATEN

LOUNGE FURNITURE TECHNICAL DATA | LOUNGE MEUBLES CARACTÉRISTIQUES TECHNIQUES

ED TABLE

45 | 75 | 105

Modell Model Modèle	ED 105 TABLE 18-04-45 75 105	ED 105 WHITE 18-05-105	ED 105 ANTHRACITE 18-06-105
DE Material/ Farbe	Tischplatte: HPL weiß matt, sehr kratz-feste Oberfläche, (ähnlich RAL 9016) Mittelteil: Weiß pulverbeschichteter Stahl & Edelstahl gebürstet Bodenplatte: Edelstahl gebürstet	Tischplatte: HPL weiß matt, sehr kratz-feste Oberfläche, (ähnlich RAL 9016) Mittelteil & Bodenplatte: Stahl pulverbeschichtet weiß matt (ähnlich RAL 9016)	Tischplatte: HPL, Anthrazit matt (ähnlich RAL 7012) mit schwarzem Kern Mittelteil & Bodenplatte: Stahl pulverbeschichtet Anthrazit matt (ähnlich RAL 7012)
Maße	L 60 x B 60 x H 45 75 105 cm	L 60 x B 60 x H 105 cm	L 60 x B 60 x H 105 cm
Gewicht	12 13 14 kg	15,5 kg	15,5 kg
Für Innenbereich	ja	ja	ja
Für Aussenbereich	-	-	-
EN Material/ Colour	Table Top: white HPL mat, very durable surface, (similar to RAL 9016) Column: white-powder-coated steel & brushed stainless steel Base: Brushed stainless steel	Table top: white HPL mat, very durable surface, (similar to RAL 9016) Centre section & base plate: powder-coated steel, white mat (similar to RAL 9016)	Table top: HPL, anthracite mat, very durable surface, (similar to RAL 7012) Centre section & base plate: powder-coated steel, anthracite mat (similar to RAL 7012)
Dimensions	L 60 x W 60 x H 45 75 105 cm	L 60 x W 60 x H 105 cm	L 60 x W 60 x H 105 cm
Weight	12 13 14 kg	15.5 kg	15.5 kg
For Indoor Use	yes	yes	yes
For Outdoor Use	-	-	-
FR Matériaux/ Couleur	Plateau de table: HPL blanc mat, surface très durable (similaire à RAL 9016) Colonne: Acier enduit de poudre blanche et acier inoxydable brossé Pied: Brossé Acier inoxydable	Plateau de table: HPL blanc mat, surface très durable (similaire à RAL 9016) Partie centrale & plateau de sol: acier revêtu par poudre anthracite mat (similaire à RAL 9016)	Plateau de table: HPL, anthracite mat (similaire à RAL 7012) Partie centrale & plateau de sol: acier revêtu par poudre anthracite mat (similaire à RAL 7012)
Dimensions	Lo 60 x La 60 x H 45 75 105 cm	Lo 60 x La 60 x H 105 cm	Lo 60 x La 60 x H 105 cm
Poids	12 13 14 kg	15,5 kg	15,5 kg
Pour Utilisation Intérieur	oui	oui	oui
Pour Utilisation Extérieure	-	-	-



ED 45



ED 75



ED 105





ED 105 WHITE



ED 105 ANTHRACITE

AIR BAR & AIR BUFFET

	OUTDOOR BAR WHITE MOD. 45-01-01	OUTDOOR BAR ANTHRACITE MOD. 45-02-01
Modell Model Modèle		
DE Material/Farbe	Aluminium pulverbeschichtet/ Weiß (ähnlich RAL 9003 Signalweiß)	Aluminium pulverbeschichtet/ Anthrazit (ähnlich RAL 7012 Basalt- grau)
Individualisierung	Auf Anfrage	Auf Anfrage
Maße	L 110 x B 57 x H 110 cm	L 110 x B 57 x H 110 cm
Arbeitsflächenhöhe	85 cm	85 cm
Gewicht	35 kg	35 kg
Für Aussenbereich	Ja	Ja
Funktionen	<ul style="list-style-type: none"> • Sonnenschirmhalterung • Halterung für zusätzliche Gewichte 	<ul style="list-style-type: none"> • Sonnenschirmhalterung • Halterung für zusätzliche Gewichte
EN Material/Colour	Aluminium powder coated/ White (similar to RAL 9003 signal white)	Aluminium powder coated/ Anthracite (similar to RAL 7012 basalt grey)
Customisation	On Request	On Request
Dimensions	L 110 x W 57 x H 110 cm	L 110 x W 57 x H 110 cm
Worktop Height	85 cm	85 cm
Weight	35 kg	35 kg
For Outdoor Use	Yes	Yes
Functions	<ul style="list-style-type: none"> • Parasol Holder • Holder for additional weights 	<ul style="list-style-type: none"> • Parasol Holder • Holder for additional weights
FR Matériaux/Couleur	Aluminium revêtu par poudre/ Blanc (similaire à RAL 9003 blanc de sécurité)	Aluminium revêtu par poudre/ Anthracite (similaire à RAL 7012 gris basalte)
Personnalisation	Sur demande	Sur demande
Dimensions	Lo 110 x La 57 x H 110 cm	Lo 110 x La 57 x H 110 cm
Hauteur du plan de travail	85 cm	85 cm
Poids	35 kg	35 kg
Pour les espaces extérieurs	Oui	Oui
Fonctions	<ul style="list-style-type: none"> • Support pour parasol • Support pour des poids supplémentaires 	<ul style="list-style-type: none"> • Support pour parasol • Support pour des poids supplémentaires

Mehr Informationen online
More information can be found online
Plus d'informations en ligne
www.moree.de



OUTDOOR BAR ANTHRACITE/WOOD
MOD. 45-03-01



Aluminium pulverbeschichtet/
Anthrazit (ähnlich RAL 7012 Basalt-
grau), Front aus Holz (Polystyrene)

Auf Anfrage

L 110 x B 57 x H 110 cm

85 cm

35 kg

Ja

- Sonnenschirmhalterung
- Halterung für zusätzliche Gewichte

OUTDOOR BUFFET WHITE/WHITE
MOD. 45-01-02



Aluminium pulverbeschichtet/
Weiß (ähnlich RAL 9003 Signalweiß)

Auf Anfrage

L 110 x B 57 x H 85 cm

85 cm

32 kg

Ja

- Sonnenschirmhalterung
- Halterung für zusätzliche Gewichte

OUTDOOR BUFFET ANTHRACITE
MOD. 45-02-02



Aluminium pulverbeschichtet/
Anthrazit (ähnlich RAL 7012 Basalt-
grau)

Auf Anfrage

L 110 x B 57 x H 85 cm

85 cm

32 kg

Ja

- Sonnenschirmhalterung
- Halterung für zusätzliche Gewichte

OUT BUFFET ANTHRACITE/WOOD
MOD. 45-03-02



Aluminium pulverbeschichtet/
Anthrazit (ähnlich RAL 7012 Basalt-
grau), Front aus Holz (Polystyrene)

Auf Anfrage

L 110 x B 57 x H 85 cm

85 cm

32 kg

Ja

- Sonnenschirmhalterung
- Halterung für zusätzliche Gewichte

Aluminium powder coated/
Anthracite (similar to RAL 7012 basalt
grey), Front in wood (Polystyrene)

On Request

L 110 x W 57 x H 110 cm

85 cm

35 kg

Yes

- Parasol Holder
- Holder for additional weights

Aluminium powder coated/
White (similar to RAL 9003 signal white)

On Request

L 110 x W 57 x H 85 cm

85 cm

32 kg

Yes

- Parasol Holder
- Holder for additional weights

Aluminium powder coated/
Anthracite (similar to RAL 7012 basalt
grey)

On Request

L 110 x W 57 x H 85 cm

85 cm

32 kg

Yes

- Parasol Holder
- Holder for additional weights

Aluminium powder coated/
Anthracite (similar to RAL 7012 basalt
grey), Front in wood (Polystyrene)

On Request

L 110 x W 57 x H 85 cm

85 cm

32 kg

Yes

- Parasol Holder
- Holder for additional weights

Aluminium revêtu par poudre/
Anthracite (similaire à RAL 7012 gris
basalte),
Face avant en bois (Polystyrène)

Sur demande

Lo 110 x La 57 x H 110 cm

85 cm

35 kg

Oui

- Support pour parasol
- Support pour des poids supplémentaires

Aluminium revêtu par poudre/
Blanc (similaire à RAL 9003 blanc de
sécurité)

Sur demande

Lo 110 x La 57 x H 85 cm

85 cm

32 kg

Oui

- Support pour parasol
- Support pour des poids supplémentaires

Aluminium revêtu par poudre/
Anthracite (similaire à RAL 7012 gris
basalte)

Sur demande

Lo 110 x La 57 x H 85 cm

85 cm

32 kg

Oui

- Support pour parasol
- Support pour des poids supplémentaires

Aluminium revêtu par poudre/
Anthracite (similaire à RAL 7012 gris
basalte),
Face avant en bois (Polystyrène)

Sur demande

Lo 110 x La 57 x H 85 cm

85 cm



32 kg

Oui

- Support pour parasol
- Support pour des poids supplémentaires



AIR BARSTOOL

Modell Model Modèle	OUTDOOR BARSTOOL WHITE MOD. 45-01-03	OUTDOOR BARSTOOL ANTHRACITE MOD. 45-02-03
		
DE Material /Farbe	Sitz: Polyester/Grau Gestell: Aluminium pulverbeschichtet/ Weiß (ähnlich RAL 9003 Signalweiß)	Sitz: Polyester/Grau Gestell: Aluminium pulverbeschichtet/ Anthrazit (ähnlich RAL 7012 Basaltgrau)
Individualisierung	Auf Anfrage	Auf Anfrage
Maße	L 36 x B 36 x H 80 cm	L 36 x B 36 x H 80 cm
Sitzhöhe	80 cm	80 cm
Gewicht	3,6 kg	3,6 kg
Für Aussenbereich	Ja	Ja
EN Material/Colour	Seat: Polyester/Grey Frame: powder-coated aluminium/ White (similar to RAL 9003 signal white)	Seat: Polyester/Grey Frame: powder-coated aluminium/ Anthracite (similar to RAL 7012 basalt grey)
Customisation	On Request	On Request
Dimensions	L 36 x W 36 x H 80 cm	L 36 x W 36 x H 80 cm
Seat Height	80 cm	80 cm
Weight	3,6 kg	3,6 kg
For Outdoor Use	Yes	Yes
FR Matériaux/Couleur	Siège: Polyester/Gris Structure: Aluminium peint par poudrage/ Blanc (similaire à RAL 9003)	Siège: Polyester/Gris Structure: Aluminium peint par poudrage/ Anthracite (similaire à RAL 7012)
Personnalisation	Sur demande	Sur demande
Dimensions	Lo 36 x La 36 x H 80 cm	Lo 36 x La 36 x H 80 cm
Hauteur du plan de travail	80 cm	80 cm
Poids	3,6 kg	3,6 kg
Pour les espaces extérieurs	Oui	Oui



AIR PARASOL

Modell Model Modèle	PARASOL WHITE/ALUMINIUM MOD. 45-01-04	PARASOL ANTHRACITE/WOOD MOD. 45-02-04
DE Material/Farbe	Stoffbezug: Olefin 190 gr/ Weiß Gestell: Aluminium/Hellgrau	Stoffbezug: Olefin 190 gr/ Anthrazit Gestell: FSC-zertifiziertes lackiertes Eukalyptusholz
Gestell	Mit 8 Rippen	Mit 8 Rippen
Maße	L 250 x B 250 x H 270 cm	L 200 x B 200 x H 250 cm
Durchgangshöhe	230 cm	200 cm
Gewicht	8 kg	9 kg
Für Aussenbereich	Ja	Ja
Funktionen	<ul style="list-style-type: none"> • Riemen Öffnungssystem • Mit Entlüftung 	<ul style="list-style-type: none"> • Riemen Öffnungssystem • Mit Entlüftung
EN Material/Colour	Fabric cover: Olefin 190 gr/ White Frame: Aluminium/Light grey	Fabric cover: Olefin 190 gr/anthracite Frame: FSC-certified lacquered eucalyptus wood
Frame	8 ribs	8 ribs
Dimensions	L 250 x W 250 x H 270 cm	L 200 x W 200 x H 250 cm
Headroom	230 cm	200 cm
Weight	8 kg	9 kg
For Outdoor Use	Yes	Yes
Functions	<ul style="list-style-type: none"> • Parasol Holder • Holder for additional weights 	<ul style="list-style-type: none"> • Pulley opening system • With airvent
FR Matériaux/Couleur	Housse en tissu: Oléfine 190 gr/ Blanc Châssis: Aluminium/Gris clair	Housse en tissu: Oléfine 190 gr/ Anthracite Châssis: Verni, certifié FSC bois d'eucalyptus
Structure	Avec 8 bras	Avec 8 bras
Dimensions	Lo 250 x La 250 x H 270 cm	Lo 200 x La 200 x H 250 cm
Hauteur de passage	230 cm	200 cm
Poids	8 kg	9 kg
Pour les espaces extérieurs	Oui	Oui
Fonctions	<ul style="list-style-type: none"> • Système d'ouverture de la courroie • Avec aération 	<ul style="list-style-type: none"> • Système d'ouverture de la courroie • Avec aération



ED ADJUSTABLE WHITE & ANTHRACITE



Weiß/
White/
Blanc



Anthrazit/
Anthracite/
Anthracite

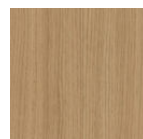

Eiche/
Oak/
Chêne

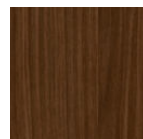

Walnuss/
Walnut/
Noyer

Modell Model Modèle	ED WHITE/WHITE ADJUSTABLE 13-02-03	ED WHITE/OAK ADJUSTABLE 13-02-31
DE Material/Farbe	Sitzfläche: Formholz lackiert, weiß Sitz: Formholz lackiert, weiß Mittelteil: Stahl pulverbeschichtet weiß & Edelstahl gebürstet Fuss: Edelstahl gebürstet	Sitzfläche: Eiche Sitz: Formholz lackiert, weiß Mittelteil: Stahl pulverbeschichtet weiß & Edelstahl gebürstet Fuss: Edelstahl gebürstet
Individualisierung	Andere Farben auf Anfrage möglich	Andere Farben auf Anfrage möglich
Maße	L 38 x B 35 x H 81 cm max./min. H 81/ 55.5 cm	L 38 x B 35 x H 81 cm max./min. H 81/ 55.5 cm
Sitzhöhe	max./min. H 77/ 51.5 cm (stufenlos verstellbar)	max./min. H 77/ 51.5 cm (stufenlos verstellbar)
Gewicht	13 kg	13 kg
Für Innenbereich	ja	ja
Funktionen	<ul style="list-style-type: none"> • Höhenverstellbar • Im Sitz integrierter Stellhebel • 360° Rotation des Sitzes 	<ul style="list-style-type: none"> • Höhenverstellbar • Im Sitz integrierter Stellhebel • 360° Rotation des Sitzes
EN Material/Colour	Seat Top: Wood painted, white Seat: Wood painted, white Column: Powder-coated white steel & stainless steel Base: Brushed stainless steel	Seat Top: Oak Seat: Wood painted, white Column: Powder-coated white steel & stainless steel Base: Brushed stainless steel
Customisation	Other colours available on request	Other colours available on request
Dimensions	L 38 x W 35 x H 81 cm max./min. 81/ 55.5 cm	L 38 x W 35 x H 81 cm max./min. 81/ 55.5 cm
Seat Height	max./min. 77/ 51.5 cm (smooth height transition)	max./min. 77/ 51.5 cm (smooth height transition)
Weight	13 kg	13 kg
For Indoor Use	yes	yes
Functions	<ul style="list-style-type: none"> • Adjustable seat height • In seat integrated lever • 360 degree rotating seat 	<ul style="list-style-type: none"> • Adjustable seat height • In seat integrated lever • 360 degree rotating seat
FR Matériaux/Couleur	Surface de siège: Bois, laqué blanc Siège: Bois, laqué blanc Colonne: Acier blanc revêtement en poudre & acier inoxydable Pied: Acier inoxydable, brossé	Surface de siège: Chêne Siège: Bois, laqué blanc Colonne: Acier blanc revêtement en poudre & acier inoxydable Pied: Acier inoxydable, brossé
Personnalisation	Autres couleurs disponibles sur demande	Autres couleurs disponibles sur demande
Dimensions	Lo 38 x La 35 x H 81 cm max./min. H 81/ 55.5 cm	Lo 38 x La 35 x H 81 cm max./min. H 81/ 55.5 cm
Hauteur du Siège	max./min. 77/ 51.5 cm (réglable en continu)	max./min. 77/ 51.5 cm (réglable en continu)
Poids	13 kg	13 kg
Pour Utilisation Intérieur	oui	oui
Fonctions	<ul style="list-style-type: none"> • La hauteur d'assise est réglable • Levier intégré dans le siège • Pivotant à 360 degrés 	<ul style="list-style-type: none"> • La hauteur d'assise est réglable • Levier intégré dans le siège • Pivotant à 360 degrés



ED WHITE/WALNUT ADJUSTABLE

13-02-32



Sitzfläche: Walnuss
Sitz: Formholz lackiert, weiß
Mittelteil: Stahl pulverbeschichtet weiß & Edelstahl gebürstet
Fuss: Edelstahl gebürstet

Andere Farben auf Anfrage möglich

L 38 x B 35 x H 81 cm

max./min. H 81/55.5 cm

 max./min. H 77/51.5 cm
(stufenlos verstellbar)

13 kg

ja

- Höhenverstellbar
- Im Sitz integrierter Stellhebel
- 360 Rotation des Sitzes

ED ANTHRACITE/WHITE ADJUSTABLE

13-02-01



Sitzfläche: Formholz lackiert, weiß
Sitz: Formholz lackiert, anthrazit
Mittelteil: Stahl pulverbeschichtet Anthrazit/Edelstahl gebürstet
Fuss: Edelstahl gebürstet

Andere Farben auf Anfrage möglich

L 38 x B 35 x H 81 cm

max./min. H 81/55.5 cm

 max./min. H 77/51.5 cm
(stufenlos verstellbar)

13 kg

ja

- Höhenverstellbar
- Im Sitz integrierter Stellhebel
- 360 Rotation des Sitzes

ED ANTHRACITE/OAK ADJUSTABLE

13-02-11



Sitzfläche: Eiche
Sitz: Formholz lackiert, anthrazit
Mittelteil: Stahl pulverbeschichtet Anthrazit/Edelstahl gebürstet
Fuss: Edelstahl gebürstet

Andere Farben auf Anfrage möglich

L 38 x B 35 x H 81 cm

max./min. H 81/55.5 cm

 max./min. H 77/51.5 cm
(stufenlos verstellbar)

13 kg

ja

- Höhenverstellbar
- Im Sitz integrierter Stellhebel
- 360 Rotation des Sitzes

ED ANTHRACITE/WALNUT ADJUSTABLE

13-02-12



Sitzfläche: Walnuss
Sitz: Formholz lackiert, anthrazit
Mittelteil: Stahl pulverbeschichtet Anthrazit/Edelstahl gebürstet
Fuss: Edelstahl gebürstet

Andere Farben auf Anfrage möglich

L 38 x B 35 x H 81 cm

max./min. H 81/55.5 cm

 max./min. H 77/51.5 cm
(stufenlos verstellbar)

13 kg

ja

- Höhenverstellbar
- Im Sitz integrierter Stellhebel
- 360 Rotation des Sitzes

Seat Top: Walnut
Seat: Wood painted, white
Column: Powder-coated white steel & stainless steel
Base: Brushed stainless steel

Other colours available on request

L 38 x W 35 x H 81 cm

max./min. 81/55.5 cm

 max./min. 77/51.5 cm
(smooth height transition)

13 kg

yes

- Adjustable seat height
- In seat integrated lever
- 360 degree rotating seat

Seat Top: Wood painted, white
Seat: Wood painted, anthracite
Column: Powder-coated anthracite steel & stainless steel
Base: Brushed stainless steel

Other colours available on request

L 38 x W 35 x H 81 cm

max./min. 81/55.5 cm

 max./min. 77/51.5 cm
(smooth height transition)

13 kg

yes

- Adjustable seat height
- In seat integrated lever
- 360 degree rotating seat

Seat Top: Oak
Seat: Wood painted, anthracite
Column: Powder-coated anthracite steel & stainless steel
Base: Brushed stainless steel

Other colours available on request

L 38 x W 35 x H 81 cm

max./min. 81/55.5 cm

 max./min. 77/51.5 cm
(smooth height transition)

13 kg

yes

- Adjustable seat height
- In seat integrated lever
- 360 degree rotating seat

Seat Top: Walnut
Seat: Wood painted, anthracite
Column: Powder-coated anthracite steel & stainless steel
Base: Brushed stainless steel

Other colours available on request

L 38 x W 35 x H 81 cm

max./min. 81/55.5 cm

 max./min. 77/51.5 cm
(smooth height transition)

13 kg

yes

- Adjustable seat height
- In seat integrated lever
- 360 degree rotating seat

Surface de siège: Noyer
Siège: Bois, laqué blanc
Colonne: Acier blanc revêtement en poudre & acier inoxydable
Pied: Acier inoxydable, brossé

Autres couleurs disponibles sur demande

Lo 38 x La 35 x H 81 cm

max./min. H 81/55.5 cm

 max./min. 77/51.5 cm
(réglable en continu)

13 kg

oui

- La hauteur d'assise est réglable
- Levier intégré dans le siège
- Pivotant à 360 degrés

Surface de siège: Bois, laqué blanc
Siège: Bois, laqué anthracite
Colonne: Acier anthracite revêtement en poudre + acier inoxydable
Pied: Acier inoxydable, brossé

Autres couleurs disponibles sur demande

Lo 38 x La 35 x H 81 cm

max./min. H 81/55.5 cm

 max./min. 77/51.5 cm
(réglable en continu)

13 kg

oui

- La hauteur d'assise est réglable
- Levier intégré dans le siège
- Pivotant à 360 degrés

Surface de siège: Chêne
Siège: Bois, laqué anthracite
Colonne: Acier anthracite revêtement en poudre + acier inoxydable
Pied: Acier inoxydable, brossé

Autres couleurs disponibles sur demande

Lo 38 x La 35 x H 81 cm

max./min. H 81/55.5 cm

 max./min. 77/51.5 cm
(réglable en continu)

13 kg

oui

- La hauteur d'assise est réglable
- Levier intégré dans le siège
- Pivotant à 360 degrés

Surface de siège: Noyer
Siège: Bois, laqué anthracite
Colonne: Acier anthracite revêtement en poudre + acier inoxydable
Pied: Acier inoxydable, brossé

Autres couleurs disponibles sur demande

Lo 38 x La 35 x H 81 cm

max./min. H 81/55.5 cm

 max./min. 77/51.5 cm
(réglable en continu)

13 kg

oui

- La hauteur d'assise est réglable
- Levier intégré dans le siège
- Pivotant à 360 degrés



ED STATIC WHITE & ANTHRACITE



Weiß/
White/
Blanc



Anthrazit/
Anthracite/
Anthracite

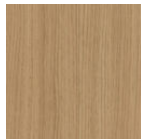

Eiche/
Oak/
Chêne

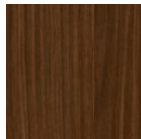

Walnuss/
Walnut/
Noyer

Modell Model Modèle	ED WHITE/WHITE STATIC 13-01-03	ED WHITE/OAK STATIC 13-01-31
DE Material/Farbe	Sitzfläche: Formholz lackiert, weiß Sitz: Formholz lackiert, weiß Mittelteil & Fuß: Stahl pulverbeschichtet weiß	Sitzfläche: Eiche Sitz: Formholz lackiert, weiß Mittelteil & Fuß: Stahl pulverbeschichtet weiß
Individualisierung	Andere Farben auf Anfrage möglich	Andere Farben auf Anfrage möglich
Maße	L 38 x B 35 x H 82.5 cm	L 38 x B 35 x H 82.5 cm
Sitzhöhe	H 78 cm (statisch)	H 78 cm (statisch)
Gewicht	11 kg	11 kg
Für Innenbereich	ja	ja
Funktionen	<ul style="list-style-type: none"> • Mehrere Sitzdesigns erhältlich • Barhockersitz Dave auch montierbar 	<ul style="list-style-type: none"> • Mehrere Sitzdesigns erhältlich • Barhockersitz Dave auch montierbar
EN Material/Colour	Seat Top: Wood painted, white Seat: Wood painted, white Column & Base: Powder-coated white	Seat Top: Oak Seat: Wood painted, white Column & Base: Powder-coated white
Customisation	Other colours available on request	Other colours available on request
Dimensions	L 38 x W 35 x H 82.5 cm	L 38 x W 35 x H 82.5 cm
Seat Height	H 78 cm (static)	H 78 cm (static)
Weight	11 kg	11 kg
For Indoor Use	yes	yes
Functions	<ul style="list-style-type: none"> • Several seat designs available • Barstool seat Dave also mountable 	<ul style="list-style-type: none"> • Several seat designs available • Barstool seat Dave also mountable
FR Matériaux/ Couleur	Surface de siège: Bois, laqué blanc Siège: Bois, laqué blanc Colonne & Pied: Acier blanc revêtement en poudre	Surface de siège: Chêne Siège: Bois, laqué blanc Colonne & Pied: Acier blanc revêtement en poudre
Personnalisation	Autres couleurs disponibles sur demande	Autres couleurs disponibles sur demande
Dimensions	Lo 38 x La 35 x H 82.5 cm	Lo 38 x La 35 x H 82.5 cm
Hauteur du Siège	H 78 cm (statique)	H 78 cm (statique)
Poids	11 kg	11 kg
Pour Utilisation Intérieur	oui	oui
Fonctions	<ul style="list-style-type: none"> • Plusieurs designs de sièges disponibles • Siège de tabouret de bar Dave également montable 	<ul style="list-style-type: none"> • Plusieurs designs de sièges disponibles • Siège de tabouret de bar Dave également montable



ED WHITE/WALNUT STATIC

13-01-32



Sitzfläche: Walnuss
Sitz: Formholz lackiert, weiß
Mittelteil & Fuß:
Stahl pulverbeschichtet weiß

Andere Farben auf Anfrage möglich

L 38 x B 35 x H 82.5 cm

H 78 cm (statisch)

11 kg

ja

- Mehrere Sitzdesigns erhältlich
- Barhockersitz Dave auch montierbar

ED ANTHRACITE/WHITE STATIC

13-01-01



Sitzfläche: Formholz lackiert, weiß
Sitz: Formholz lackiert, anthrazit
Mittelteil & Fuß:
Stahl pulverbeschichtet Anthrazit

Andere Farben auf Anfrage möglich

L 38 x B 35 x H 82.5 cm

H 78 cm (statisch)

11 kg

ja

- Mehrere Sitzdesigns erhältlich
- Barhockersitz Dave auch montierbar

ED ANTHRACITE/OAK STATIC

13-01-11



Sitzfläche: Eiche
Sitz: Formholz lackiert, anthrazit
Mittelteil & Fuß:
Stahl pulverbeschichtet Anthrazit

Andere Farben auf Anfrage möglich

L 38 x B 35 x H 82.5 cm

H 78 cm (statisch)

11 kg

ja

- Mehrere Sitzdesigns erhältlich
- Barhockersitz Dave auch montierbar

ED ANTHRACITE/WALNUT STATIC

13-01-12



Sitzfläche: Walnuss
Sitz: Formholz lackiert, anthrazit
Mittelteil & Fuß:
Stahl pulverbeschichtet Anthrazit

Andere Farben auf Anfrage möglich

L 38 x B 35 x H 82.5 cm

H 78 cm (statisch)

11 kg

ja

- Mehrere Sitzdesigns erhältlich
- Barhockersitz Dave auch montierbar

Seat Top: Walnut
Seat: Wood painted, white
Column & Base: Powder-coated white

Other colours available on request

L 38 x W 35 x H 82.5 cm

H 78 cm (static)

11 kg

yes

- Several seat designs available
- Barstool seat Dave also mountable

Seat Top: Wood painted, white
Seat: Wood painted, anthracite
Column & Base:
Powder-coated anthracite

Other colours available on request

L 38 x W 35 x H 82.5 cm

H 78 cm (static)

11 kg

yes

- Several seat designs available
- Barstool seat Dave also mountable

Seat Top: Oak
Seat: Wood painted, anthracite
Column & Base:
Powder-coated anthracite

Other colours available on request

L 38 x W 35 x H 82.5 cm

H 78 cm (static)

11 kg

yes

- Several seat designs available
- Barstool seat Dave also mountable

Seat Top: Walnut
Seat: Wood painted, anthracite
Column & Base:
Powder-coated anthracite

Other colours available on request

L 38 x W 35 x H 82.5 cm

H 78 cm (static)

11 kg

yes

- Several seat designs available
- Barstool seat Dave also mountable

Surface de siège: Noyer
Siège: Bois, laqué blanc
Colonne & Pied:
Acier blanc revêtement en poudre

Autres couleurs disponibles sur demande

Lo 38 x La 35 x H 82.5 cm

H 78 cm (statique)

11 kg

oui

- Plusieurs designs de sièges disponibles
- Siège de tabouret de bar Dave également montable

Surface de siège: Bois, laqué blanc
Siège: Bois, laqué anthracite
Colonne & Pied:
Acier anthracite revêtement en poudre

Autres couleurs disponibles sur demande

Lo 38 x La 35 x H 82.5 cm

H 78 cm (statique)

11 kg

oui

- Plusieurs designs de sièges disponibles
- Siège de tabouret de bar Dave également montable

Surface de siège: Chêne
Siège: Bois, laqué anthracite
Colonne & Pied:
Acier anthracite revêtement en poudre

Autres couleurs disponibles sur demande

Lo 38 x La 35 x H 82.5 cm

H 78 cm (statique)

11 kg

oui

- Plusieurs designs de sièges disponibles
- Siège de tabouret de bar Dave également montable

Surface de siège: Noyer
Siège: Bois, laqué anthracite
Colonne & Pied:
Acier anthracite revêtement en poudre

Autres couleurs disponibles sur demande

Lo 38 x La 35 x H 82.5 cm

H 78 cm (statique)

11 kg

oui

- Plusieurs designs de sièges disponibles
- Siège de tabouret de bar Dave également montable



ED ADJUSTABLE WHITE & ANTHRACITE



Weiß/
White/
Blanc



Anthrazit/
Anthracite/
Anthracite

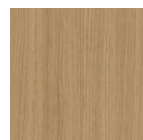

Eiche/
Oak/
Chêne

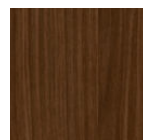

Walnuss/
Walnut/
Noyer

Modell Model Modèle	ED WHITE/WHITE ADJUSTABLE 13-03-03	ED WHITE/OAK ADJUSTABLE 13-03-31
	 	 
DE Material/Farbe	Sitzfläche: Formholz lackiert, weiß Sitz: Formholz lackiert, weiß Mittelteil & Fuß: Stahl pulverbeschichtet weiß	Sitzfläche: Eiche Sitz: Formholz lackiert, weiß Mittelteil & Fuß: Stahl pulverbeschichtet weiß
Individualisierung	Andere Farben auf Anfrage möglich	Andere Farben auf Anfrage möglich
Maße	L 38 x B 35 x H 81 cm max./min. H 81/ 55.5 cm	L 38 x B 35 x H 81 cm max./min. H 81/ 55.5 cm
Sitzhöhe	max./min. H 77/ 51.5 cm (stufenlos verstellbar)	max./min. H 77/ 51.5 cm (stufenlos verstellbar)
Gewicht	13 kg	13 kg
Für Innenbereich	ja	ja
Funktionen	<ul style="list-style-type: none"> • Höhenverstellbar • 360 Rotation des Sitzes 	<ul style="list-style-type: none"> • Höhenverstellbar • 360 Rotation des Sitzes
EN Material/Colour	Seat Top: Wood painted, white Seat: Wood painted, white Column & Base: Powder-coated white	Seat Top: Oak Seat: Wood painted, white Column & Base: Powder-coated white
Customisation	Other colours available on request	Other colours available on request
Dimensions	L 38 x W 35 x H 81 cm max./min. 81/ 55.5 cm	L 38 x W 35 x H 81 cm max./min. 81/ 55.5 cm
Seat Height	max./min. 77/ 51.5 cm (smooth height transition)	max./min. 77/ 51.5 cm (smooth height transition)
Weight	13 kg	13 kg
For Indoor Use	yes	yes
Functions	<ul style="list-style-type: none"> • Adjustable seat height • 360 degree rotating seat 	<ul style="list-style-type: none"> • Adjustable seat height • 360 degree rotating seat
FR Matériaux/Couleur	Surface de siège: Bois, laqué blanc Siège: Bois, laqué blanc Colonne & Pied: Acier blanc revêtement en poudre	Surface de siège: Bois, Chêne Siège: Bois, laqué blanc Colonne & Pied: Acier blanc revêtement en poudre
Personnalisation	Autres couleurs disponibles sur demande	Autres couleurs disponibles sur demande
Dimensions	Lo 38 x La 35 x H 81 cm max./min. H 81/ 55.5 cm	Lo 38 x La 35 x H 81 cm max./min. H 81/ 55.5 cm
Hauteur du Siège	max./min. 77/ 51.5 cm (réglable en continu)	max./min. 77/ 51.5 cm (réglable en continu)
Poids	13 kg	13 kg
Pour Utilisation Intérieur	oui	oui
Fonctions	<ul style="list-style-type: none"> • La hauteur d'assise est réglable • Pivotant à 360 degrés 	<ul style="list-style-type: none"> • La hauteur d'assise est réglable • Pivotant à 360 degrés



ED WHITE/WALNUT ADJUSTABLE

13-03-32



Sitzfläche: Walnuss
Sitz: Formholz lackiert, weiß
Mittelteil & Fuß:
Stahl pulverbeschichtet weiß

Andere Farben auf Anfrage möglich

L 38 x B 35 x H 81 cm
max./min. H 81/ 55.5 cm
max./min. H 77/ 51.5 cm
(stufenlos verstellbar)

13 kg

ja

- Höhenverstellbar
- 360 Rotation des Sitzes

ED ANTHRACITE/WHITE ADJUSTABLE

13-03-01



Sitzfläche: Formholz lackiert, weiß
Sitz: Formholz lackiert, anthrazit
Mittelteil & Fuß:
Stahl pulverbeschichtet Anthrazit

Andere Farben auf Anfrage möglich

L 38 x B 35 x H 81 cm
max./min. H 81/ 55.5 cm
max./min. H 77/ 51.5 cm
(stufenlos verstellbar)

13 kg

ja

- Höhenverstellbar
- 360 Rotation des Sitzes

ED ANTHRACITE/OAK ADJUSTABLE

13-03-11



Sitzfläche: Eiche
Sitz: Formholz lackiert, anthrazit
Mittelteil & Fuß:
Stahl pulverbeschichtet Anthrazit

Andere Farben auf Anfrage möglich

L 38 x B 35 x H 81 cm
max./min. H 81/ 55.5 cm
max./min. H 77/ 51.5 cm
(stufenlos verstellbar)

13 kg

ja

- Höhenverstellbar
- 360 Rotation des Sitzes

ED ANTHRACITE/WALNUT ADJUSTABLE

13-03-12



Sitzfläche: Walnuss
Sitz: Formholz lackiert, anthrazit
Mittelteil & Fuß:
Stahl pulverbeschichtet Anthrazit

Andere Farben auf Anfrage möglich

L 38 x B 35 x H 81 cm
max./min. H 81/ 55.5 cm
max./min. H 77/ 51.5 cm
(stufenlos verstellbar)

13 kg

ja

- Höhenverstellbar
- 360 Rotation des Sitzes

Seat Top: Walnut
Seat: Wood painted, white
Column & Base: Powder-coated white

Other colours available on request

L 38 x W 35 x H 81 cm
max./min. 81/ 55.5 cm
max./min. 77/ 51.5 cm
(smooth height transition)

13 kg

yes

- Several seat designs available
- Barstool seat Dave also mountable

Seat Top: Wood painted, white
Seat: Wood painted, anthracite
Column & Base:
Powder-coated anthracite

Other colours available on request

L 38 x W 35 x H 81 cm
max./min. 81/ 55.5 cm
max./min. 77/ 51.5 cm
(smooth height transition)

13 kg

yes

- Several seat designs available
- Barstool seat Dave also mountable

Seat Top: Oak
Seat: Wood painted, anthracite
Column & Base:
Powder-coated anthracite

Other colours available on request

L 38 x W 35 x H 81 cm
max./min. 81/ 55.5 cm
max./min. 77/ 51.5 cm
(smooth height transition)

13 kg

yes

- Several seat designs available
- Barstool seat Dave also mountable

Seat Top: Walnut
Seat: Wood painted, anthracite
Column & Base:
Powder-coated anthracite

Other colours available on request

L 38 x W 35 x H 81 cm
max./min. 81/ 55.5 cm
max./min. 77/ 51.5 cm
(smooth height transition)

13 kg

yes

- Several seat designs available
- Barstool seat Dave also mountable

Surface de siège: Noyer
Siège: Bois, laqué blanc
Colonne & Pied:
Acier blanc revêtement en poudre

Autres couleurs disponibles sur demande

Lo 38 x La 35 x H 81 cm
max./min. H 81/ 55.5 cm
max./min. 77/ 51.5 cm
(réglable en continu)

13 kg

oui

- La hauteur d'assise est réglable
- Pivotant à 360 degrés

Surface de siège: Bois, laqué blanc
Siège: Bois, laqué anthracite
Colonne & Pied:
Acier anthracite revêtement en poudre

Autres couleurs disponibles sur demande

Lo 38 x La 35 x H 81 cm
max./min. H 81/ 55.5 cm
max./min. 77/ 51.5 cm
(réglable en continu)

13 kg

oui

- La hauteur d'assise est réglable
- Pivotant à 360 degrés

Surface de siège: Chêne
Siège: Bois, laqué anthracite
Colonne & Pied:
Acier anthracite revêtement en poudre

Autres couleurs disponibles sur demande

Lo 38 x La 35 x H 81 cm
max./min. H 81/ 55.5 cm
max./min. 77/ 51.5 cm
(réglable en continu)

13 kg

oui

- La hauteur d'assise est réglable
- Pivotant à 360 degrés

Surface de siège: Noyer
Siège: Bois, laqué anthracite
Colonne & Pied:
Acier anthracite revêtement en poudre

Autres couleurs disponibles sur demande

Lo 38 x La 35 x H 81 cm
max./min. H 81/ 55.5 cm
max./min. 77/ 51.5 cm
(réglable en continu)

13 kg

oui

- La hauteur d'assise est réglable
- Pivotant à 360 degrés



DAVE STATIC WHITE & ANTHRACITE

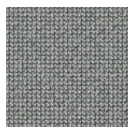

Hellgrau/
Light Grey/
Gris clair



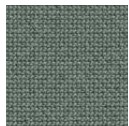

Anthrazit/
Anthracite/
Anthracite



Salbei/
Sage/
Sauge



Weinrot/
Wine Red/
Lie de Vin

	DAVE WHITE STATIC 42-01-0X	DAVE ANTHRACITE STATIC 42-02-0X
Modell Model Modèle		
DE Material/Farbe (Gestell)	Mittelteil: Stahl pulverbeschichtet Bodenplatte: Stahl pulverbeschichtet/ Weiß matt (ähnlich RAL 9016)	Mittelteil: Stahl pulverbeschichtet Bodenplatte: Stahl pulverbeschichtet/ Anthrazit, matt (ähnlich RAL 7012)
Farbe (Sitz)	42-01-01 DAVE Weiß/Sitz Hellgrau 42-01-02 DAVE Weiß/Sitz Anthrazit 42-01-03 DAVE Weiß/Sitz Salbei 42-01-04 DAVE Weiß/Sitz Weinrot	42-02-01 DAVE Anthrazit/Sitz Hellgrau 42-02-02 DAVE Anthrazit/Sitz Anthrazit 42-02-03 DAVE Anthrazit/Sitz Salbei 42-02-04 DAVE Anthrazit/Sitz Weinrot
Material (Sitz): Formholz, gepolstert	<ul style="list-style-type: none"> • Stoffbezug: Polyester 98% recycled, 2% PE • Abrieb: Martindale 100.000 • Pilling: 4-5 • Lichtechtheitsskala: 5-8 • Reibechtheitsskala: (nass/trocken) 4-5/4-5 • Entflammbarkeit: BS EN 1021 1 & 2 • CA TB 117-2013/ASTM E 84 Klasse I • Umwelt Label: STANDARD 100 	<ul style="list-style-type: none"> • Stoffbezug: Polyester 98% recycled, 2% PE • Abrieb: Martindale 100.000 • Pilling: 4-5 • Lichtechtheitsskala: 5-8 • Reibechtheitsskala: (nass/trocken) 4-5/4-5 • Entflammbarkeit: BS EN 1021 1 & 2 • CA TB 117-2013/ASTM E 84 Klasse I • Umwelt Label: STANDARD 100
Maße/Sitzhöhe	T 41 x B 37 x H 90 cm/H 78 cm (statisch)	T 41 x B 37 x H 90 cm/78 cm (statisch)
Maße Sitz	T 41 x B 37 x H 12 cm	T 41 x B 37 x H 12 cm
Gewicht	10 kg	10 kg
Für Innenbereich	Home & Contract	Home & Contract
EN Material/Colour (Stand)	Middle part: Steel, Powder-coated Base: Steel, Powder-coated White matte (similar RAL 9016)	Middle part: Steel, Powder-coated Base: Steel, Powder-coated Anthracite matte (similar RAL 7012)
Colour (Seat)	42-01-01 DAVE White/Seat Light Grey 42-01-02 DAVE White/Seat Anthracite 42-01-03 DAVE White/Seat Sage 42-01-04 DAVE White/Seat Wine Red	42-02-01 DAVE Anthracite/Seat Light Grey 42-02-02 DAVE Anthracite/Seat Anthracite 42-02-03 DAVE Anthracite/Seat Sage 42-02-04 DAVE Anthracite/Seat Wine Red
Material (Seat): Molded wood, upholstered	<ul style="list-style-type: none"> • Polyester fabric 98% recycled, 2% PE • Abrasion: Rubs martindale 100,000 • Pilling: 4-5 • Light fastness: 5-8 • Rubbing fastness: (wet/dry)/4-5/4-5 • Flammability: BS EN 1021 1&2 • CA TB 117-2013/ASTM E 84 Class I • Environment: STANDARD 100 	<ul style="list-style-type: none"> • Polyester fabric 98% recycled, 2% PE • Abrasion: Rubs martindale 100,000 • Pilling: 4-5 • Light fastness: 5-8 • Rubbing fastness: (wet/dry)/4-5/4-5 • Flammability: BS EN 1021 1&2 • CA TB 117-2013/ASTM E 84 Class I • Environment: STANDARD 100
Dimensions/Seat Height	D 41 x W 37 x H 90 cm/H 78 cm (static)	D 41 x W 37 x H 90 cm/H 78 cm (static)
Dimensions/Seat	D 41 x W 37 x H 12 cm	D 41 x W 37 x H 12 cm
Weight	10 kg	10 kg
For Indoor Use	Home & Contract	Home & Contract
FR Matériaux/Couleur	Colonne: Acier, Revêtement en poudre Plaque d'assise: Acier, Revêtement en poudre/Blanc mat (similaire RAL 9016)	Colonne: Acier, Revêtement en poudre Plaque d'assise: Acier, Revêtement en poudre/Blanc mat (similaire RAL 7012)
Couleur Siège	42-01-01 DAVE Blanc/Gris Clair 42-01-02 DAVE Blanc/Anthracite 42-01-03 DAVE Blanc/Sauge 42-01-04 DAVE Blanc/Lie de Vin	42-02-01 DAVE Anthracite/Gris Clair 42-02-02 DAVE Anthracite/Anthracite 42-02-03 DAVE Anthracite/Sauge 42-02-04 DAVE Anthracite/Lie de Vin
Matériaux Siège: Bois Moulé, Rembourré	<ul style="list-style-type: none"> • Tissu Polyester 98% recyclé, 2% PE • Abrasion: Testé Martindale 100,000 • Pilling: 4-5 • Solidité lumière: 5-8 • Solidité frottement: (mouillé/sec) 4-5/4-5 • Inflammabilité: BS EN 1021 1&2 • CA TB 117-2013/ASTM E 84 Classe I • Environnement: STANDARD 100 	<ul style="list-style-type: none"> • Tissu Polyester 98% recyclé, 2% PE • Abrasion: Testé Martindale 100,000 • Pilling: 4-5 • Solidité lumière: 5-8 • Solidité frottement: (mouillé/sec) 4-5/4-5 • Inflammabilité: BS EN 1021 1&2 • CA TB 117-2013/ASTM E 84 Classe I • Environnement: STANDARD 100
Dimensions/Hauteur d'assise	L 41 x L 37 x H 90 cm/H 78 cm (statique)	L 41 x L 37 x H 90 cm/H 78 cm (statique)
Dimensions Siège	L 41 x L 37 x H 12 cm	L 41 x L 37 x H 12 cm
Poids	10 kg	10 kg
Pour Utilisation Intérieur	Maison & Collectivité	Maison & Collectivité

DAVE ADJUSTABLE WHITE & ANTHRACITE

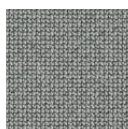

Hellgrau/
Light Grey/
Gris clair



Anthrazit/
Anthracite/
Anthracite

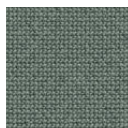

Salbei/
Sage/
Sauge

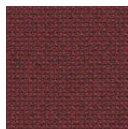

Weinrot/
Wine Red/
Lie de Vin

DAVE WHITE ADJUSTABLE

42-03-0X



Modell Model Modèle		
DE Material/Farbe (Gestell)	Mittelteil: Stahl pulverbeschichtet Bodenplatte: Stahl pulverbeschichtet/ Weiß matt (ähnlich RAL 9016)	Mittelteil: Stahl pulverbeschichtet Bodenplatte: Stahl pulverbeschichtet/ Anthrazit, matt (ähnlich RAL 7012)
Farbe (Sitz)	42-03-01 DAVE Weiß/Sitz Hellgrau 42-03-02 DAVE Weiß/Sitz Anthrazit 42-03-03 DAVE Weiß/Sitz Salbei 42-03-04 DAVE Weiß/Sitz Weinrot	42-04-01 DAVE Anthrazit/Sitz Hellgrau 42-04-02 DAVE Anthrazit/Sitz Anthrazit 42-04-03 DAVE Anthrazit/Sitz Salbei 42-04-04 DAVE Anthrazit/Sitz Weinrot
Material (Sitz): Formholz, gepolstert	<ul style="list-style-type: none"> • Stoffbezug: Polyester 98% recycled, 2% PE • Abrieb: Martindale 100.000 • Pilling: 4-5 • Lichtechtheitskala: 5-8 • Reibechtheitskala: (nass/trocken) 4-5/4-5 • Entflammbarkeit: BS EN 1021 1 & 2 • CA TB 117-2013/ASTM E 84 Klasse I • Umwelt Label: STANDARD 100 	<ul style="list-style-type: none"> • Stoffbezug: Polyester 98% recycled, 2% PE • Abrieb: Martindale 100.000 • Pilling: 4-5 • Lichtechtheitskala: 5-8 • Reibechtheitskala: (nass/trocken) 4-5/4-5 • Entflammbarkeit: BS EN 1021 1 & 2 • CA TB 117-2013/ASTM E 84 Klasse I • Umwelt Label: STANDARD 100
Maße/Sitzhöhe	T 41 x B 37 x H 89 cm H 77-55.5 cm (max/min) höhenverstellbar	T 41 x B 37 x H 89 cm H 77-55.5 cm (max/min) höhenverstellbar
Maße Sitz	T 41 x B 37 x H 12 cm	T 41 x B 37 x H 12 cm
Gewicht	13 kg	13 kg
Für Innenbereich	Home & Contract	Home & Contract

EN

Material/Colour (Stand)	Middle part: Steel, Powder-coated Base: Steel, Powder-coated White matte (similar RAL 9016)	Middle part: Steel, Powder-coated Base: Steel, Powder-coated Anthracite matte (similar RAL 7012)
Colour (Seat)	42-01-01 DAVE White/Seat Light Grey 42-01-02 DAVE White/Seat Anthracite 42-01-03 DAVE White/Seat Sage 42-01-04 DAVE White/Seat Wine Red	42-02-01 DAVE Anthracite/Seat Light Grey 42-02-02 DAVE Anthracite/Seat Anthracite 42-02-03 DAVE Anthracite/Seat Sage 42-02-04 DAVE Anthracite/Seat Wine Red
Material (Seat): Molded wood, upholstered	<ul style="list-style-type: none"> • Polyester fabric 98% recycled, 2% PE • Abrasion: Rubs martindale 100,000 • Pilling: 4-5 • Light fastness: 5-8 • Rubbing fastness: (wet/dry)/4-5/4-5 • Flammability: BS EN 1021 1&2 • CA TB 117-2013/ASTM E 84 Class I • Environment: STANDARD 100 	<ul style="list-style-type: none"> • Polyester fabric 98% recycled, 2% PE • Abrasion: Rubs martindale 100,000 • Pilling: 4-5 • Light fastness: 5-8 • Rubbing fastness: (wet/dry)/4-5/4-5 • Flammability: BS EN 1021 1&2 • CA TB 117-2013/ASTM E 84 Class I • Environment: STANDARD 100
Dimensions/Seat Height	D 41 x W 37 x H 89 cm H 77-55.5 cm (max/min) Height-adjustable	D 41 x W 37 x H 89 cm H 77-55.5 cm (max/min) Height-adjustable
Dimensions/Seat	D 41 x W 37 x H 12 cm	D 41 x W 37 x H 12 cm
Weight	13 kg	13 kg
For Indoor Use	Home & Contract	Home & Contract

FR

Matériaux/Couleur	Colonne: Acier, Revêtement en poudre Plaque d'assise: Acier, Revêtement en poudre/Blanc mat (similaire RAL 9016)	Colonne: Acier, Revêtement en poudre Plaque d'assise: Acier, Revêtement en poudre/Blanc mat (similaire RAL 7012)
Couleur Siège	42-01-01 DAVE Blanc/Gris Clair 42-01-02 DAVE Blanc/Anthracite 42-01-03 DAVE Blanc/Sauge 42-01-04 DAVE Blanc/Lie de Vin	42-02-01 DAVE Anthracite/Gris Clair 42-02-02 DAVE Anthracite/Anthracite 42-02-03 DAVE Anthracite/Sauge 42-02-04 DAVE Anthracite/Lie de Vin
Matériaux Siège: Bois Moulé, Rembourré	<ul style="list-style-type: none"> • Tissu Polyester 98% recyclé, 2% PE • Abrasion: Testé Martindale 100,000 • Pilling: 4-5 • Solidité lumière: 5-8 • Solidité frottement: (mouillé/sec) 4-5/4-5 • Inflammabilité: BS EN 1021 1&2 • CA TB 117-2013/ASTM E 84 Classe I • Environnement: STANDARD 100 	<ul style="list-style-type: none"> • Tissu Polyester 98% recyclé, 2% PE • Abrasion: Testé Martindale 100,000 • Pilling: 4-5 • Solidité lumière: 5-8 • Solidité frottement: (mouillé/sec) 4-5/4-5 • Inflammabilité: BS EN 1021 1&2 • CA TB 117-2013/ASTM E 84 Classe I • Environnement: STANDARD 100
Dimensions/Hauteur d'assise	L 41 x L 37 x H 89 cm H 77-55.5 cm (max/min) hauteur réglable	L 41 x L 37 x H 90 cm/H 78 cm H 77-55.5 cm (max/min) hauteur réglable
Dimensions Siège	L 41 x L 37 x H 12 cm	L 41 x L 37 x H 12 cm
Poids	13 kg	13 kg
Pour Utilisation Intérieur	Maison & Collectivité	Maison & Collectivité

DAVE COLORS

Stoffbezug aus 98%
recyceltem Material
Fabric cover made from
98% recycled material
Housse en tissu à 98% de
matières recyclées



- Barhockergestell
- Stool frame
- Châssis de tabouret

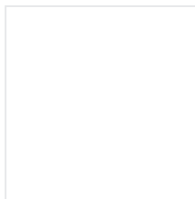

Weiss (Ähnlich RAL 9010)
White (Similar to RAL 9010)
Blanc (similaire à RAL 9010)



Anthrazit (Ähnlich RAL 7012)
Anthracite (Similar to RAL 7012)
Anthracite (similaire à RAL 7012)

- Sitz-Standardfarben
- Seat standard colors
- Couleurs standard du siège

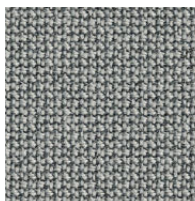

Hellgrau/
Light Grey/
Gris clair

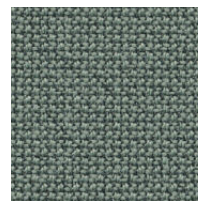

Salbei/
Sage/
Sauge



Anthrazit/
Anthracite/
Anthracite

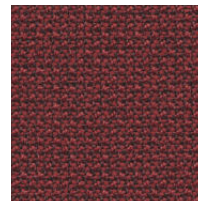

Weinrot/
Wine Red/
Lie de Vin

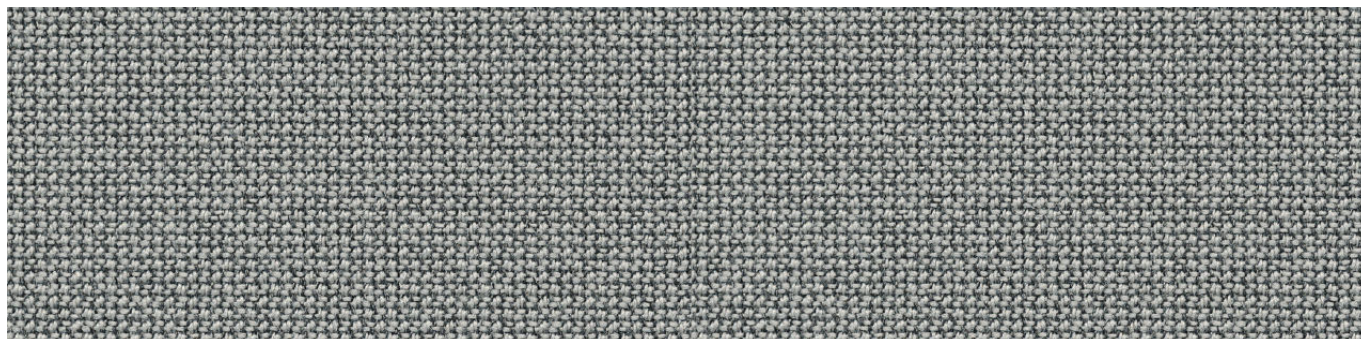
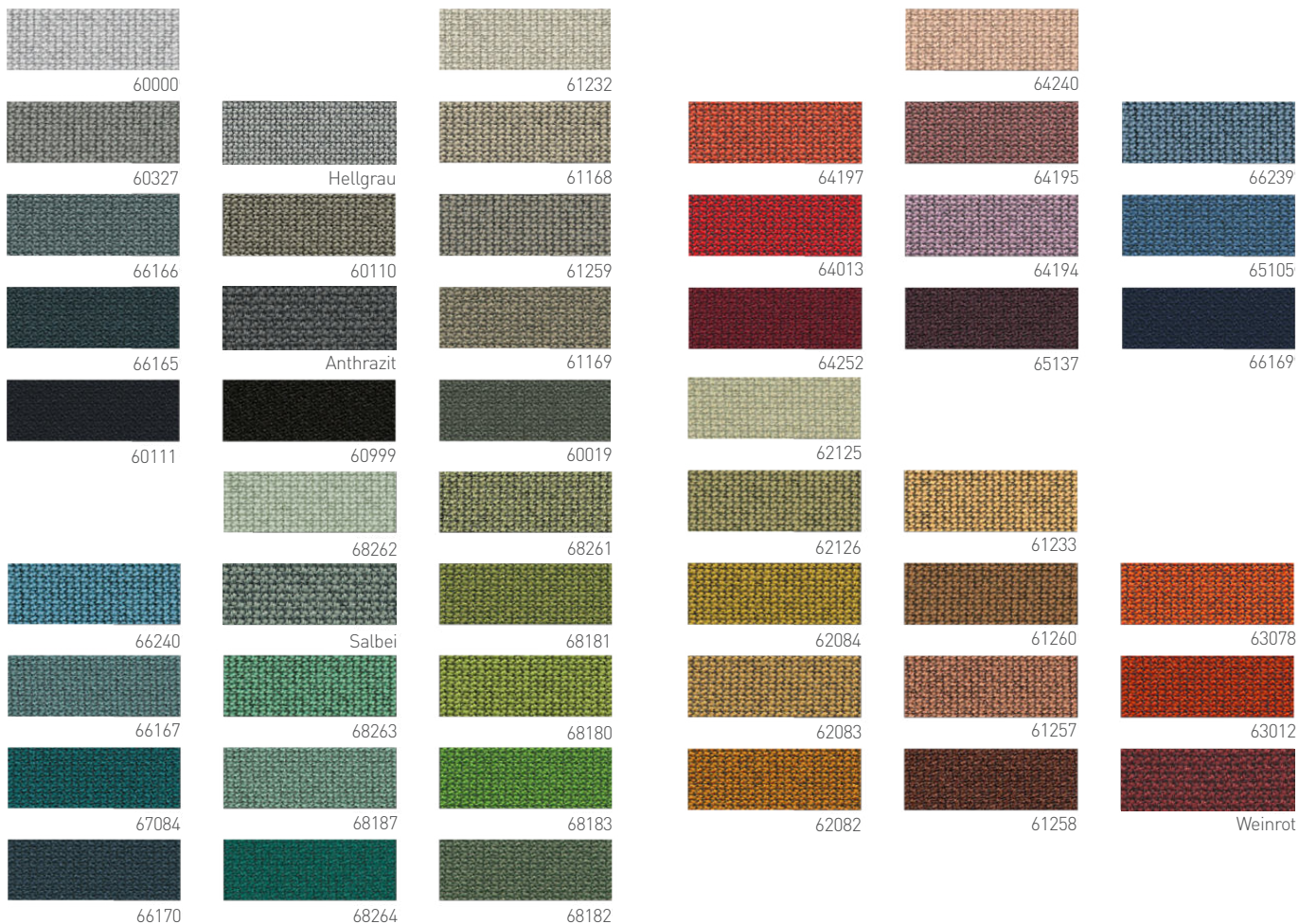



ILLUMINIERTE MÖBEL - TECHNISCHE DATEN

ILLUMINATED FURNITURE - TECHNICAL DATA | MEUBLES ILLUMINÉS - CARACTÉRISTIQUES TECHNIQUES

BUBBLE











Inklusive: Glasplatte oder Sitzkissen
Including: Glass top or cushion
Inclus: Panneau de verre ou coussin

	BUBBLE X 15-07-01	BUBBLE INDOOR 15-01-01
Modell Model Modèle		
Maße Dimensions Dimensions	ca. approx. env. Ø 68 x H 41 cm	ca. approx. env. Ø 68 x H 41 cm
Gewicht Weight Poids	ca. approx. env. 7 kg	ca. approx. env. 7 kg
DE Material	PE seidenmatt, UV-beständig	PE seidenmatt, UV-beständig
Farbe	Weiß, transluzent	Weiß, transluzent
Lampenfassung	-	1x E27/ max. 40 W E27
Leuchtmittel	Ohne Beleuchtung	LED Leuchtmittel E27, max. 5,5 W, EEK: F, max. 500 lm Lebensdauer: 15.000 h
Fernbedienung	-	-
Aufladbarer Akku/ Ladezeit Laufzeit (in Farbwechsel)	-	-
Ladegerät	-	-
Verkabelung	-	ca. 3 m mit Fußschalter, klar
Spannung	-	230 V~, 50 Hz
Schutzklasse	-	II
Für Innenbereich	Ja	Ja
Für Aussenbereich	Ja	-
EN Material	PE semi gloss, UV resistant	PE semi gloss, UV resistant
Colour	White, translucent	White, translucent
Lamp Holder	-	1x E27/ max. 40 W E27
Illuminant	without Light	LED bulb E27, max. 5,5 W, EEC: F, max. 500 lm Life span: 15.000 h
Remote Control	-	-
Rechargeable battery/ Charging Time Runtime (in colour change)	-	-
Charger	-	-
Cable	-	approx. 3 m with foot switch, clear
Voltage	-	230 V~, 50 Hz
Protection Class	-	II
For Indoor Use	Yes	Yes
For Outdoor Use	Yes	-
FR Matériaux	PE satiné, résistant aux rayons UV	PE satiné, résistant aux rayons UV
Couleur	Blanc, translucide	Blanc, translucide
Support de Lampe	-	1x E27/ max. 40 W E27
Ampoule	sans lumière	illuminant à DEL E27, max. 5,5 W, CÉ: F, max. 500 lm Durée de vie: 15.000 h
Télécommande	-	-
Batterie/ Temps de Charge Autonomie (en changement de couleur)	-	-
Chargeur	-	-
Câblage	-	env. 3 m avec pédale, transparent
Tension	-	230 V~, 50 Hz
Catégorie	-	II
Pour Utilisation Intérieur	Oui	Oui
Pour Utilisation Extérieure	Oui	-

BUBBLE



Inklusive: Glasplatte oder Sitzkissen
Including: Glass top or cushion
Inclus: Panneau de verre ou coussin

Modell Model Modèle	BUBBLE INDOOR LED 15-01-01-LED	BUBBLE OUTDOOR 15-02-01
	    	   
Maße Dimensions Dimensions	ca. approx. env. Ø 68 x H 41 cm	ca. approx. env. Ø 68 x H 41 cm
Gewicht Weight Poids	ca. approx. env. 7 kg	ca. approx. env. 8 kg
DE Material	PE seidenmatt, UV-beständig	PE seidenmatt, UV-beständig
Farbe	Weiß, transluzent	Weiß, transluzent
Lampenfassung	1x E27/ max. 40 W E27	1x E27/ max. 40 W E27
Leuchtmittel	Multicolor LED Leuchtmittel E27, max. 9 W, EEK: F, max. 850 lm Lebensdauer: 50.000 h	LED Leuchtmittel E27, max. 5,5 W, EEK: F, max. 500 lm Lebensdauer: 15.000 h
Fernbedienung	mit Funkfernbedienung	-
Aufladbarer Akku/ Ladezeit Laufzeit (in Farbwechsel)	-	-
Ladegerät	-	-
Verkabelung	ca. 3 m mit Fußschalter, klar	ca. 5 m, schwarz
Spannung	230 V~, 50 Hz	230 V~, 50 Hz
Schutzklasse	II	II
Für Innenbereich	Ja	-
Für Aussenbereich	-	IP44
EN Material	PE semi gloss, UV resistant	PE semi gloss, UV resistant
Colour	White, translucent	White, translucent
Lamp Holder	1x E27/ max. 40 W E27	1x E27/ max. 40 W E27
Illuminant	LED multicolour light bulb E27, max. 9 W, EEC: F, max. 850 lm, Life span: 50.000 h	LED bulb E27, max. 5,5 W, EEC: F, max. 500 lm Life span: 15.000 h
Remote Control	with Radio remote control	-
Rechargeable battery/ Charging Time Runtime (in colour change)	-	-
Charger	-	-
Cable	approx. 3 m with foot switch, clear	approx. 5 m, black
Voltage	230 V~, 50 Hz	230 V~, 50 Hz
Protection Class	II	II
For Indoor Use	Yes	-
For Outdoor Use	-	IP44
FR Matériaux	PE satiné, résistant aux rayons UV	PE satiné, résistant aux rayons UV
Couleur	Blanc, translucide	Blanc, translucide
Support de Lampe	1x E27/ max. 40 W E27	1x E27/ max. 40 W E27
Ampoule	LED multicolours E27, max. 9 W, CÉ: F, max. 850 lm, Durée de vie: 50.000 h	Illuminant à DEL E27, max. 5,5 W, CÉ: F, max. 500 lm Durée de vie: 15.000 h
Télécommande	avec télécommande radio	-
Batterie/ Temps de Charge Autonomie (en changement de couleur)	-	-
Chargeur	-	-
Câblage	env. 3 m avec pédale, transparent	env. 5 m, noir
Tension	230 V~, 50 Hz	230 V~, 50 Hz
Catégorie	II	II
Pour Utilisation Intérieur	Oui	-
Pour Utilisation Extérieure	-	IP44

BUBBLE OUTDOOR LED

15-02-01-LED



ca. | approx. | env. Ø 68 x H 41 cm

ca. | approx. | env. 8 kg

PE seidenmatt, UV-beständig

Weiß, transluzent

1x E27/ max. 40 W E27

Multicolor LED Leuchtmittel E27,
max. 9 W, EEC: F, max. 850 lm
Lebensdauer: 50.000 h

mit Funkfernbedienung

-

-

ca. 5 m, schwarz

230 V~, 50 Hz

II

-

IP44

PE semi gloss, UV resistant

White, translucent

1x E27/ max. 40 W E27

LED multicolour light bulb E27,
max. 9 W, EEC: F, max. 850 lm,
Life span: 50.000 h

with Radio remote control

-

-

approx. 5 m, black

230 V~, 50Hz

II

-

IP44

PE satiné, résistant aux rayons UV

Blanc, translucide

1x E27/ max. 40 W E27

LED multicolours E27,
max. 9 W, CÉ: F, max. 850 lm,
Durée de vie: 50.000 h

avec télécommande radio

-

-

env. 5 m, noir

230 V~, 50Hz

II

-

IP44

BUBBLE LED ACCU OUTDOOR

15-04-02



ca. | approx. | env. Ø 68 x H 41 cm

ca. | approx. | env. 6 kg

PE seidenmatt, UV-beständig

weiß, transluzent

Eingebaute LED-Einheit (ausbaubar)

Multicolor & Warmweiß 2700 K,
Kaltweiß 6000 K LEDs, max. 7.2 W,
max. 810 lm, Lebensdauer: 30000 h

IR

3.7 V, 2 x 2600 mAh (Li-Ion)/ 10 h
11 h

100-240 V~, 50/60 Hz, Vout 5 V, 1,2 A

1,2 m

100-240 VAC, 50/ 60 Hz

III (Produkt), II (Ladegerät)

-

IP54

PE semi gloss, UV resistant

white, translucent

Built-in LED Unit (removable)

Multicolor & warm white 2700 K,
cool white 6000 K LEDs, max. 7.2 W,
max. 810 lm, life span: 30000 h

IR

3.7 V, 2 x 2600 mAh (Li-Ion)/ 10 h
11 h

100-240 V~, 50/60 Hz, Vout 5 V, 1,2 A

1,2 m

100-240 VAC, 50/ 60 Hz

III (Product), II (Charger)

-

IP54

PE satiné, résistant aux rayons UV

blanc, translucide

Unité à LED intégrée (amovible)

DEL multicolores & blanc chaud 2700
K, blanc froid 6000 K, max. 7,2 W,
max. 810 lm, durée de vie: 30000 h

IR

3.7 V, 2 x 2600 mAh (Li-Ion)/ 10 h
11 h

100-240 V~, 50/60 Hz, Vout 5 V, 1,2 A

1,2 m

100-240 VAC, 50/ 60 Hz

III (Produit), II (Chargeur)

-

IP54

BUBBLE CUSHIONS & GLASSTOP



Modell	15-11-01 Sitzkissen Orange
	15-12-01 Sitzkissen Rot
	15-13-01 Sitzkissen Violett
	15-14-01 Sitzkissen Grün
	15-15-01 Sitzkissen Anthrazit

Material	Filtz, 100% Wolle
Maße	Ø 40 x H 5 cm
Gewicht	ca. 0.2 kg

Modell	15-10-01 Glastischplatte
Material	Sicherheitsglas, klar
Maße	Ø 40 x H 5 cm
Gewicht	1,5 kg

Model	15-11-01 Orange cushion
	15-12-01 Red cushion
	15-13-01 Purple cushion
	15-14-01 Green cushion
	15-15-01 Anthracite cushion

Material	Felt, 100% wool
Dims	Ø 40 x H 5 cm
Weight	approx. 0.2 kg

Model	15-10-01 Glasstop
Material	Safety glass, transparent
Dims	Ø 40 x H 5 cm
Weight	1.5 kg

Modèle	15-11-01 Orange coussin
	15-12-01 Rouge coussin
	15-13-01 Pourpre coussin
	15-14-01 Vert coussin
	15-15-01 Anthracite coussin

Matériaux	Feutre, 100% laine
Dims	Ø 40 x H 5 cm
Poids	env. 0.2 kg

Modèle	15-10-01 Panneau de verre
Matériaux	Verre de sécurité, transparent
Dims	Ø 40 x H 5 cm
Poids	1,5 kg



Inklusive: 5 mm Glasplatte
Including: 5 mm glass top
Inclus: 5 mm tablette en verre

Modell Model Modèle	ORA HOME X 28-17-01	ORA HOME LED PRO 28-16-01
DE	Material Holz, lackiert	MDF, lackiert
Farbe Weiß seidenmatt		Weiß, seidenmatt
Maße L 1100 x B 700 x H 290 mm		L 1100 x B 700 x H 290 mm
Gewicht ca. 26.3 kg		ca. 28.2 kg
Lampenfassung -		Eingebaute LED-Einheit (ausbaubar)
Leuchtmittel -		Multicolor LEDs, max 29 W, EEC: G, max. 1500 lm, Lebensdauer: 30000 h Warmweißes Licht 2700 K
Fernbedienung -		Funk
Aufladbarer Akku/ Ladezeit Laufzeit (in Farbwechsel)	-	-
Ladegerät -		-
Verkabelung -		ca. 3 m, rot
Spannung -		200-240 VAC, 50 Hz
Schutzklasse -		II
Für Innenbereich Ja		Ja
EN	Material Wood, spray painted	Wood, spray painted
Colour White, satin		White, satin
Dimensions L 1100 x W 700 x H 290 mm		L 1100 x W 700 x H 290 mm
Weight approx. 26.3 kg		approx. 28.2 kg
Lamp Holder -		Built-In LED Unit (removable)
Illuminant -		Multicolor LEDs, max 29 W, EEC: G, max. 1500 lm, life span: 30000 h Warm white light 2700 K
Remote Control -		Radio
Rechargeable battery/ ChargingTime Runtime (in colour change)	-	-
Charger -		-
Cable -		approx. 3 m, red
Voltage -		200-240 VAC, 50 Hz
Protection Class -		II
For Indoor Use Yes		Yes
FR	Matériaux Bois, laqué	Bois, laqué
Couleur Blanc satin		Blanc satin
Dimensions Lo 1100 x La 700 x H 290 mm		Lo 1100 x La 700 x H 290 mm
Poids env. 26.3 kg		env. 28.2 kg
Support de Lampe -		Unité à LED intégrée (amovible)
Ampoule -		LED multicolore, max 29 W, CÉ: F, max. 1500 lm, durée de vie: 30000 h Lumière blanc chaud 2700K
Télécommande -		Radio contrôle
Batterie/ Temps de Charge Autonomie (en changement de couleur)	-	-
Chargeur -		-
Câblage -		env. 3 m, rouge
Tension -		200-240 VAC, 50 Hz
Catégorie -		II
Pour utilisation intérieur Oui		Oui

Modell | Model | Modèle

ORA HOME LED ACCU

28-26-01



DE	Material	MDF, lackiert
	Farbe	Weiß, seidenmatt
	Maße	L 1100 x B 700 x H 290 mm
	Gewicht	ca. 28,2 kg
	LED-Einheit mit wiederaufladbaren Akkus	wird in das Produkt eingelegt
	Leuchtmittel	Multicolor & Warmweiß 2700 K, Kaltweiß 6000 K LEDs, max. 7.2 W, max. 810 lm, Lebensdauer: 30000 h
	Fernbedienung	IR
	Aufladbarer Akku/ Ladezeit	3.7 V, 2 x 2600 mAh (Li-Ion)/ 10 h
	Laufzeit (in Farbwechsel)	11 h
	Ladegerät	100-240 V~, 50/60 Hz, Vout 5 V, 1,2 A
	Verkabelung	-
	Spannung	100-240 V~, 50/60 Hz
	Schutzklasse	III (Produkt), II (Ladegerät)
	Für Innenbereich	Ja

EN	Material	Wood, spray painted
	Colour	White, satin
	Dimensions	L 1100 x W 700 x H 290 mm
	Weight	approx. 28.2 kg
	LED unit with rechargeable batteries	is inserted into the product
	Illuminant	Multicolor & warm white 2700 K, cool white 6000 K LEDs, max. 7.2 W, max. 810 lm, life span: 30000 h
	Remote Control	IR
	Rechargeable battery/ ChargingTime	3.7 V, 2 x 2600 mAh (Li-Ion)/ 10 h
	Runtime (in colour change)	11 h
	Adapter	100-240 V~, 50/60 Hz, Vout 5 V, 1,2 A
	Cable	-
	Voltage	100-240 V~, 50/60 Hz
	Protection Class	III (Product), II (Charger)
	For Indoor Use	Yes

FR	Matériaux	Bois, laqué
	Couleur	Blanc satin
	Dimensions	Lo 1100 x La 700 x H 290 mm
	Poids	env. 28.2 kg
	Unité DEL avec batteries rechargeables	est inséré dans le produit
	Ampoule	DEL multicolores & blanc chaud 2700 K, blanc froid 6000 K, max. 7,2 W, max. 810 lm, durée de vie: 30000 h
	Télécommande	IR
	Batterie/ Temps de Charge	3.7 V, 2 x 2600 mAh (Li-Ion)/ 10 h
	Autonomie (en changement de couleur)	11 h
	Chargeur	100-240 V~, 50/60 Hz, Vout 5 V, 1,2 A
	Câblage	-
	Tension	100-240 VAC, 50/ 60 Hz
	Catégorie	III (Produit), II (Chargeur)
	Pour utilisation intérieur	Oui







LOUNGE



Inklusive: 5 mm Glasplatte
Including: 5 mm glass top
Inclus: 5 mm tablette en verre

LOUNGE INDOOR

LOUNGE INDOOR LED

Modell Model Modèle	04-05-01	04-05-01-LED
	 E27 	 E27  
Maße Dimensions Dimensions	ca. approx. env. Ø 84 cm x H 34 cm	ca. approx. env. Ø 84 cm x H 34 cm
Gewicht Weight Poids	ca. approx. env. 7 kg	ca. approx. env. 7 kg
DE Material	ABS, PMMA glänzend, beschichtet, UV-beständig	ABS, PMMA glänzend, beschichtet, UV-beständig
Farbe	weiß, transluzent	weiß, transluzent
Lampenfassung/Watt	1x E27/ max. 40 W E27	1x E27/ max. 40 W E27
Leuchtmittel	LED Leuchtmittel E27, max. 5,5 W, EEC: F, max. 500 lm Lebensdauer: 15.000 h	Multicolor LED Leuchtmittel E27, max. 9 W, EEC: F, max. 850 lm Lebensdauer: 50.000 h
Fernbedienung	-	mit Funkfernbedienung
Aufladbarer Akku/ Ladezeit Laufzeit (in Farbwechsel)	-	-
Ladegerät	-	-
Verkabelung	ca. 3 m mit Fußschalter, klar	ca. 3 m mit Fußschalter, klar
Spannung	230 V~, 50 Hz	230 V~, 50 Hz
Schutzklasse	II	II
Für Innenbereich	Ja	Ja
Für Aussenbereich	-	-
EN Material	ABS, PMMA coated, gloss finish, UV resistant	ABS, PMMA coated, gloss finish, UV resistant
Colour	white, translucent	white, translucent
Lamp Holder	1x E27/ max. 40 W E27	1x E27/ max. 40 W E27
Illuminant	LED bulb E27, max. 5,5 W, EEC: F, max. 500 lm Life span: 15.000 h	LED multicolour light bulb E27, max. 9 W, EEC: F, max. 850 lm, Life span: 50.000 h
Remote Control	-	with Radio remote control
Rechargeable battery/ ChargingTime Runtime (in colour change)	-	-
Charger	-	-
Cable	approx. 3 m cable, clear	approx. 3 m cable, clear
Voltage	230 V~, 50 Hz	230 V~, 50 Hz
Protection Class	II	II
For Indoor Use	Yes	Yes
For Outdoor Use	-	-
FR Matériaux	ABS, PMMA, brillant, résistant aux rayons UV	ABS, PMMA, brillant, résistant aux rayons UV
Couleur	blanc, translucide	blanc, translucide
Support de Lampe	1x E27/ max. 40 W E27	1x E27/ max. 40 W E27
Ampoule	illuminant à DEL E27, max. 5,5 W, CÉ: F, max. 500 lm Durée de vie: 15.000 h	LED multicolours E27 max. 9 W, CÉ: F, max. 850 lm Durée de vie: 50.000 h
Télécommande	-	avec télécommande radio
Batterie/ Temps de Charge Autonomie (en changement de couleur)	-	-
Chargeur	-	-
Câblage	env. 3 m, transparent	env. 3 m, transparent
Tension	230 V~, 50 Hz	230 V~, 50 Hz
Catégorie	II	II
Pour Utilisation Intérieur	Oui	Oui
Pour Utilisation Extérieure	-	-

LOUNGE OUTDOOR

04-03-01



ca. | approx. | env. Ø 84 cm x H 34 cm

ca. | approx. | env. 8 kg

ABS, PMMA glänzend, beschichtet, UV-beständig

weiß, transluzent

1x E27/ max. 40 W E27

LED-Leuchtmittel E27, 5.5W, 500 Lm, Warmweiß (3000 K), EEK: F
Lebensdauer: 15.000 h

-

-

-

-

ca. 5 m, schwarz

230 V~, 50 Hz

II

-

IP44

LOUNGE OUTDOOR LED

04-03-01-LED



ca. | approx. | env. Ø 84 cm x H 34 cm

ca. | approx. | env. 8 kg

ABS, PMMA glänzend, beschichtet, UV-beständig

weiß, transluzent

1x E27/ max. 40 W E27

Multicolor LED Leuchtmittel E27, max. 9 W, EEK: F, max. 850 lm, Lebensdauer: 50.000 h

mit Funkfernbedienung

-

-

-

ca. 5 m Kabel, schwarz

230 V~, 50Hz

II

-

IP44

LOUNGE LED ACCU OUTDOOR

04-09-01



ca. | approx. | env. Ø 84 cm x H 34 cm

ca. | approx. | env. 7 kg

ABS, PMMA glänzend, beschichtet, UV-beständig

weiß, transluzent

Eingebaute LED-Einheit (ausbaubar)

Multicolor & Warmweiß 2700 K, Kaltweiß 6000 K LEDs, max. 7.2 W, max. 810 lm, Lebensdauer: 30000 h

IR

3.7 V, 2 x 2600 mAh (Li-Ion)/ 10 Std. 11 Std.

100-240 V~, 50/60 Hz, Vout 5 V, 1,2 A

1,2 m

100-240 VAC, 50/ 60 Hz

III (Produkt), II (Ladegerät)

-

IP54

ABS, PMMA coated, gloss finish, UV resistant

white, translucent

1x E27/ max. 40 W E27

LED bulb E27, max. 5,5 W, EEC: F, max. 500 lm
Life span: 15.000 h

-

-

-

-

approx. 5 m, black

230 V~, 50 Hz

II

-

IP44

ABS, PMMA coated, gloss finish, UV resistant

white, translucent

1x E27/ max. 40 W E27

LED multicolor light bulb E27, max. 9 W EEC: F, max. 850 lm, Life span: 50.000 h

with Radio remote control

-

-

-

approx. 5 m cable, black

230 V~, 50Hz

II

-

IP44

ABS, PMMA coated, gloss finish, UV resistant

white, translucent

Built-In LED Unit (removable)

Multicolor & warm white 2700 K, cool white 6000 K LEDs, max. 7.2 W, max. 810 lm, life span: 30000 h

IR

3.7 V, 2 x 2600 mAh (Li-Ion)/ 10 h 11 h

100-240 V~, 50/60 Hz, Vout 5 V, 1,2 A

1,2 m

100-240 VAC, 50/ 60 Hz

III (Product), II (Charger)

-

IP54

ABS, PMMA, brillant, résistant aux rayons UV

blanc, translucide

1x E27/ max. 40 W E27

luminant à DEL E27, max. 5,5 W, CÉ: F, max. 500 lm
Durée de vie: 15.000 h

-

-

-

-

env. 5 m, noir

230 V~, 50 Hz

II

-

IP44

ABS, PMMA, brillant, résistant aux rayons UV

blanc, translucide

1x E27/ max. 40 W E27

LED multicoloreurs E27 max. 9 W, CÉ: F, max. 850 lm
Durée de vie: 50.000 h

avec télécommande radio

-

-

-

env. 5 m, noir

230 V~, 50Hz

II

-

IP44

ABS, PMMA, brillant, résistant aux rayons UV

blanc, translucide

Unité à LED intégrée (amovible)

DEL multicolores & blanc chaud 2700 K, blanc froid 6000 K, max. 7,2 W, max. 810 lm, durée de vie: 30000 h

IR

3.7 V, 2 x 2600 mAh (Li-Ion)/ 10 h 12 h

100-240 V~, 50/60 Hz, Vout 5 V, 1,2 A

1,2 m

100-240 VAC, 50/ 60 Hz

III (Objet), II (Chargeur)



-

IP54

LOUNGE VARIATION



Inklusive: 5 mm Glasplatte
Including: 5 mm glass top
Inclus: 5 mm tablette en verre

	LOUNGE VARIATION 07-01-01	LOUNGE VARIATION LED PRO 07-03-01
Modell Model Modèle	07-01-01	07-03-01
	  	    
Maße Dimensions Dimensions	ca. approx. env. Ø 84 cm x H 18 cm	ca. approx. env. Ø 84 cm x H 18 cm
Gewicht Weight Poids	ca. approx. env. 8 kg	ca. approx. env. 9 kg
DE Material	ABS, PMMA glänzend beschichtet, UV-beständig	ABS, PMMA glänzend beschichtet, UV-beständig
Farbe	weiß, transluzent	weiß, transluzent
Lampenfassung	1x E27/ max. 40 W E27	1x E27/ max. 40 W E27
Leuchtmittel	LED Leuchtmittel E27, max. 5,5 W, EEC: F, max. 500 lm Lebensdauer: 15.000 h	Multicolor LED Leuchtmittel E27, max. 9 W, EEC: F, max. 850 lm Lebensdauer: 50.000 h
Fernbedienung	-	mit Funkfernbedienung
Aufladbarer Akku/ Ladezeit Laufzeit (in Farbwechsel)	-	-
Ladegerät	-	-
Verkabelung	ca. 3,5 m , klar	ca. 3,5 m , klar
Spannung	230 V~, 50 Hz	230 V~, 50 Hz
Schutzklasse	II	II
Für Innenbereich	Ja	Ja
Für Aussenbereich	-	-
EN Material	ABS, PMMA coated, gloss finish, UV resistant	ABS, PMMA coated, gloss finish, UV resistant
Colour	white, translucent	white, translucent
Lamp Holder	1x E27/ max. 40 W E27	1x E27/ max. 40 W E27
Illuminant	LED bulb E27, max. 5,5 W, EEC: F, max. 500 lm Life span: 15.000 h	LED multicolour light bulb E27, max. 9 W, EEC: F, max. 850 lm, Life span: 50.000 h
Remote Control	-	with Radio remote control
Rechargeable battery/ ChargingTime Runtime (in colour change)	-	-
Charger	-	-
Cable	approx. 3.5 m, clear	approx. 3.5 m, clear
Voltage	230 V~, 50 Hz	230 V~, 50 Hz
Protection Class	II	II
For Indoor Use	Yes	Yes
For Outdoor Use	-	-
FR Matériaux	ABS, PMMA, brillant, résistant aux rayons UV	ABS, PMMA, brillant, résistant aux rayons UV
Couleur	blanc, translucide	blanc, translucide
Support de Lampe	1x E27/ max. 40 W E27	1x E27/ max. 40 W E27
Ampoule	illuminant à DEL E27, max. 5,5 W, CÉ: F, max. 500 lm Durée de vie: 15.000 h	LED multicolours E27, max. 9 W, CÉ: F, max. 850 lm, Durée de vie: 50.000 h
Télécommande	-	avec télécommande radio
Batterie/ Temps de Charge Autonomie (en changement de couleur)	-	-
Chargeur	-	-
Câblage	env. 3,5 m, transparent	env. 3,5 m, transparent
Tension	230 V~, 50 Hz	230 V~, 50 Hz
Catégorie	II	II
Pour Utilisation Intérieur	Oui	Oui
Pour Utilisation Extérieure	-	-

LOUNGE VARIATION OUTDOOR

07-02-01

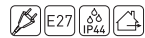

ca. | approx. | env. Ø 84 cm x H 18 cm

ca. | approx. | env. 9 kg

ABS, PMMA glänzend
beschichtet, UV-beständig

weiß, transluzent

1x E27/ max. 40 W E27

LED Leuchtmittel E27,
max. 5,5 W, EEC: F, max. 500 lm
Lebensdauer: 15.000 h

-

-

-

-

ca. 4,5 m, schwarz

230 V~, 50 Hz

II

-

IP44

L. VARIATION LED PRO OUTDOOR

07-03-02



ca. | approx. | env. Ø 84 cm x H 18 cm

ca. | approx. | env. 9 kg

ABS, PMMA glänzend
beschichtet, UV-beständig

weiß, transluzent

1x E27/ max. 40 W E27

Multicolor LED Leuchtmittel E27,
max. 9 W, EEC: F, max. 850 lm
Lebensdauer: 50.000 h

mit Funkfernbedienung

-

-

-

ca. 4,5 m, schwarz

230 V~, 50 Hz

II

-

IP44

L. VARIATION LED ACCU OUTDOOR

07-13-01



ca. | approx. | env. Ø 84 cm x H 18 cm

ca. | approx. | env. 9 kg

ABS, PMMA glänzend
beschichtet, UV-beständig

weiß, transluzent

Eingebaute LED-Einheit (ausbaubar)

Multicolor & Warmweiß 2700 K,
Kaltweiß 6000 K LEDs, max. 7,2 W,
max. 810 lm, Lebensdauer: 30000 h

IR

3.7 V, 2 x 2600 mAh (Li-Ion)/ 10 h
11 h

100-240 V~, 50/60 Hz, Vout 5 V, 1,2 A

1,2 m

100-240 VAC, 50/ 60 Hz

III (Produkt), II (Ladegerät)

-

IP54

ABS, PMMA coated, gloss finish,
UV resistant

white, translucent

1x E27/ max. 40 W E27

LED bulb E27,
max. 5,5 W, EEC: F, max. 500 lm
Life span: 15.000 h

-

-

-

-

approx. 4.5 m, black

230 V~, 50 Hz

II

-

IP44

ABS, PMMA coated, gloss finish,
UV resistant

white, translucent

1x E27/ max. 40 W E27

LED multicolour light bulb E27,
max. 9 W, EEC: F, max. 850 lm,
Life span: 50.000 h

with Radio remote control

-

-

-

approx. 4.5 m, black

230 V~, 50 Hz

II

-

IP44

ABS, PMMA coated, gloss finish,
UV resistant

white, translucent

Built-In LED Unit (removable)

Multicolor & warm white 2700 K,
cool white 6000 K LEDs, max. 7.2 W,
max. 810 lm, life span: 30000 h

IR

3.7 V, 2 x 2600 mAh (Li-Ion)/ 10 h
11 h

100-240 V~, 50/60 Hz, Vout 5 V, 1,2 A

1,2 m

100-240 VAC, 50/ 60 Hz

III (Product), II (Charger)

-

IP54

ABS, PMMA, brillant,
résistant aux rayons UV

blanc, translucide

1x E27/ max. 40 W E27

illuminant à DEL E27,
max. 5,5 W, CÉ: F, max. 500 lm
Durée de vie: 15.000 h

-

-

-

-

env. 4.5 m, noir

230 V~, 50 Hz

II

-

IP44

ABS, PMMA, brillant,
résistant aux rayons UV

blanc, translucide

1x E27/ max. 40 W E27

LED multicolours E27,
max. 9 W, CÉ: F, max. 850 lm,
Durée de vie: 50.000 h

avec télécommande radio

-

-

-

env. 4.5 m, noir

230 V~, 50 Hz

II

-

IP44

ABS, PMMA, brillant,
résistant aux rayons UV

blanc, translucide

Unité à LED intégrée (amovible)

DEL multicolores & blanc chaud 2700
K, blanc froid 6000 K, max. 7,2 W,
max. 810 lm, durée de vie: 30000 h

IR

3.7 V, 2 x 2600 mAh (Li-Ion)/ 10 h
11 h

Vout 7.5 V / 0,6 A

1,2 m

100-240 VAC, 50/ 60 Hz

III (Objet), II (Chargeur)

-





IP54

LOUNGE

45 | 55 | 75 | 105



Inklusive: 5 mm Glasplatte
Including: 5 mm glass top
Inclus: 5 mm tablette en verre

	LOUNGE INDOOR	LOUNGE LED PRO
Modell Model Modèle	45: 07-06-04 75: 07-06-02	55: 07-06-01 105: 07-06-03
	  	    
Maße Dimensions Dimensions	ca. l approx. env. Ø 84 x H 45/55/75/105 cm	ca. l approx. env. Ø 84 x H 45/55/75/105 cm
Gewicht Weight Poids	ca. l approx. env. 24.4/24.9/25.1/31.5 kg	ca. l approx. env. 24.4/24.9/25.1/31.5 kg
DE Material/ Farbe	ABS, PMMA glänzend, weiß transluzent, UV-beständig; Aluminium gebürstet	ABS, PMMA glänzend, weiß transluzent, UV-beständig; Aluminium gebürstet
Lampenfassung	1x E27/ max. 40 W E27	1x E27/ max. 40 W E27
Leuchtmittel	LED Leuchtmittel E27, max. 5,5 W, EEC: F, max. 500 lm Lebensdauer: 15.000 h	Multicolor LED Leuchtmittel E27, max. 9 W, EEC: F, max. 850 lm Lebensdauer: 50.000 h
Fernbedienung	-	mit Funkfernbedienung
Aufladbarer Akku/ Ladezeit Laufzeit (in Farbwechsel)	-	-
Ladegerät	-	-
Verkabelung	ca. 2,5 - 3 m, klar	ca. 2,5 - 3 m, klar
Spannung	230 V~, 50 Hz	230 V~, 50 Hz
Schutzklasse	II	II
Für Innenbereich	Ja	Ja
Für Aussenbereich	-	-
EN Material/ Colour	ABS, PMMA glossy, white translucent UV resistant; aluminium brushed	ABS, PMMA glossy, white translucent UV resistant; aluminium brushed
Lamp Holder	1x E27/ max. 40 W E27	1x E27/ max. 40 W E27
Illuminant	LED bulb E27, max. 5,5 W, EEC: F, max. 500 lm Life span: 15.000 h	LED multicolour light bulb E27, max. 9 W, EEC: F, max. 850 lm, Life span: 50.000 h
Remote Control	-	with Radio remote control
Rechargeable battery/ ChargingTime Runtime (in colour change)	-	-
Charger	-	-
Cable	2,5 - 3 m, clear	2,5 - 3 m, clear
Voltage	230 V~, 50 Hz	230 V~, 50 Hz
Protection Class	II	II
For Indoor Use	Yes	Yes
For Outdoor Use	-	-
FR Matériaux/ Couleur	ABS, PMMA brillant, blanc, translucide résistant aux rayons UV; Aluminium brossé	ABS, PMMA brillant, blanc, translucide résistant aux rayons UV; Aluminium brossé
Support de Lampe	1x E27/ max. 40 W E27	1x E27/ max. 40 W E27
Ampoule	Illuminant à DEL E27, max. 5,5 W, CÉ: F, max. 500 lm Durée de vie: 15.000 h	LED multicolours E27, max. 9 W, CÉ: F, max. 850 lm, Durée de vie: 50.000 h
Télécommande	-	avec télécommande radio
Batterie/ Temps de Charge Autonomie (en changement de couleur)	-	-
Chargeur	-	-
Câblage	env. 2,5 - 3 m, transparent	env. 2,5 - 3 m, transparent
Tension	230 V~, 50 Hz	230 V~, 50 Hz
Catégorie	II	II
Pour Utilisation Intérieure	Oui	Oui
Pour Utilisation Extérieure	-	-

LOUNGE OUTDOOR

45: 07-07-04 55: 07-07-01
75: 07-07-02 105: 07-07-03



ca. | approx. | env. Ø 84 x H 45/55/75/105 cm
ca. | approx. | env. 24.4/24.9/25.1/31.5 kg

ABS, PMMA glänzend, weiß transluzent,
UV-beständig; Aluminium gebürstet

1x E27/ max. 40 W E27

LED Leuchtmittel E27,
max. 5,5 W, EEC: F, max. 500 lm
Lebensdauer: 15.000 h

-

-

-

-

ca. 3,5 - 4 m, schwarz

230 V~, 50 Hz

II

-

IP44

LOUNGE LED PRO OUTDOOR

45: 07-08-06 55: 07-08-07
75: 07-08-08 105: 07-08-05



ca. | approx. | env. Ø 84 x H 45/55/75/105 cm
ca. | approx. | env. 24.4/24.9/25.1/31.5 kg

ABS, PMMA glänzend, weiß transluzent,
UV-beständig; Aluminium gebürstet

1x E27/ max. 40 W E27

Multicolor LED Leuchtmittel E27,
max. 9 W mit Fernbedienung, EEC: F,
max. 850 lm, Lebensdauer: 50.000 h
mit Funkfernbedienung

-

-

-

ca. 5 m, schwarz

230 V~, 50Hz

II

-

IP44

LOUNGE LED ACCU OUTDOOR

45: 07-11-04 55: 07-11-01
75: 07-11-02 105: 07-11-03



ca. | approx. | env. Ø 84 x H 45/55/75/105 cm
ca. | approx. | env. 24.4/24.9/25.1/31.5 kg

ABS, PMMA glänzend, weiß transluzent,
UV-beständig; Aluminium gebürstet

Eingebaute LED-Einheit [ausbaubar]

Multicolor & Warmweiß 2700 K,
Kaltweiß 6000 K LEDs, max. 7.2 W,
max. 810 lm, Lebensdauer: 30000 h

IR

3.7 V, 2 x 2600 mAh (Li-Ion)/ 10 h
11 h

100-240 V~, 50/60 Hz, Vout 5 V, 1,2 A

1,2 m

100-240 VAC, 50/ 60 Hz

III (Produkt), II (Ladegerät)

-

IP54

ABS, PMMA glossy, white translucent
UV resistant; aluminium brushed

1x E27/ max. 40 W E27

LED bulb E27,
max. 5,5 W, EEC: F, max. 500 lm
Life span: 15.000 h

-

-

-

-

3,5 - 4 m, black

230 V~, 50 Hz

II

-

IP44

ABS, PMMA glossy, white translucent
UV resistant; aluminium brushed

1x E27/ max. 40 W E27

LED multicolor light bulb E27,
max. 9 W, EEC: F, max. 850 lm,
Lifespan: 50.000 h

with Radio remote control

-

-

-

approx. 5 m, black

230 V~, 50Hz

II

-

IP44

ABS, PMMA glossy, white translucent
UV resistant; aluminium brushed

Built-In LED Unit [removable]

Multicolor & warm white 2700 K,
cool white 6000 K LEDs, max. 7.2 W,
max. 810 lm, life span: 30000 h

IR

3.7 V, 2 x 2600 mAh (Li-Ion)/ 10 h
11 h

100-240 V~, 50/60 Hz, Vout 5 V, 1,2 A

1,2 m

100-240 VAC, 50/ 60 Hz

III (Product), II (Charger)

-

IP54

ABS, PMMA brillant, blanc, translucide
résistant aux rayons UV; Aluminium
brossé

1x E27/ max. 40 W E27

illuminant à DEL E27,
max. 5,5 W, CE: F, max. 500 lm
Durée de vie: 15.000 h

-

-

-

-

env. 3,5 - 4 m, noir

230 V~, 50 Hz

II

-

IP44

ABS, PMMA brillant, blanc, translucide
résistant aux rayons UV; Aluminium
brossé

1x E27/ max. 40 W E27

LED multicolours E27,
max. 9 W, CE: F, max. 850 lm,
Durée de vie: 50.000 h

avec télécommande radio

-

-

-

env. 5 m, noir

230 V~, 50Hz

II

-

IP44

ABS, PMMA brillant, blanc, translucide
résistant aux rayons UV; Aluminium
brossé

Unité à LED intégrée (amovible)

DEL multicolores & blanc chaud 2700
K, blanc froid 6000 K, max. 7,2 W,
max. 810 lm, durée de vie: 30000 h

IR

3.7 V, 2 x 2600 mAh (Li-Ion)/ 10 h
11 h

100-240 V~, 50/60 Hz, Vout 5 V, 1,2 A

1,2 m

100-240 VAC, 50/ 60 Hz

III (Objet), II (Chargeur)



-

IP54

STUDIO 36 | 45 | 75 | 105



Inklusive: 5 mm Glasplatte
Including: 5 mm glass top
Inclus: 5 mm tablette en verre

	STUDIO 36/ 45/ 75/ 105 INDOOR	STUDIO LED PRO
Modell Model Modèle	36: 16-02-01 45: 16-02-02 75: 16-02-03 105: 16-02-04	36: 16-04-01 45: 16-04-02 75: 16-04-03 105: 16-04-04
	 E27 	  
Maße Dimensions Dimensions	ca. approx. env. 70x100 H 36/45/75/105 cm	ca. approx. env. 70x100 H 36/45/75/105 cm
Gewicht Weight Poids	ca. approx. env. 34.9/35.7/38.6/41.6 kg	ca. approx. env. 34.9/35.7/38.6/41.6 kg
DE Material/ Farbe	ABS, PMMA glänzend, weiß transluzent, UV-beständig; Edelstahl gebürstet	ABS, PMMA glänzend, weiß transluzent, UV-beständig; Edelstahl gebürstet
Lampenfassung	1x E27/ max. 40 W E27	1x E27/ max. 40 W E27
Leuchtmittel	LED Leuchtmittel E27, max. 5,5 W, EEC: F, max. 500 lm Lebensdauer: 15.000 h	Multicolor LED Leuchtmittel E27, max. 9 W, EEC: F, max. 850 lm Lebensdauer: 50.000 h
Fernbedienung	-	mit Fernbedienung
Aufladbarer Akku/ Ladezeit Laufzeit (in Farbwechsel)	-	-
Ladegerät	-	-
Verkabelung	ca. 2,5 - 3 m, klar	ca. 2,5 - 3 m, transparent
Spannung	200-240 VAC, 50 Hz	200-240 VAC, 50 Hz / MAX 15 W
Schutzklasse	II	II
Für Innenbereich	Ja	Ja
Für Aussenbereich	-	-
EN Material/ Colour	ABS, PMMA glossy, white translucent UV resistant; Stainless steel brushed	ABS, PMMA glossy, white translucent UV resistant; Stainless steel brushed
Lamp Holder	1x E27/ max. 40 W E27	1x E27/ max. 40 W E27
Illuminant	LED bulb E27, max. 5,5 W, EEC: F, max. 500 lm Life span: 15.000 h	LED multicolour light bulb E27, max. 9 W, EEC: F, max. 850 lm, Life span: 50.000 h
Remote Control	-	with Radio remote control
Rechargeable battery/ ChargingTime Runtime (in colour change)	-	-
Charger	-	-
Cable	2,5 - 3 m, clear	2,5 - 3 m, transparent
Voltage	200-240 VAC, 50 Hz	200-240 VAC, 50 Hz / MAX. 15 W
Protection Class	II	II
For Indoor Use	Yes	Yes
For Outdoor Use	-	-
FR Matériaux/ Couleur	ABS, PMMA brillant, blanc, translucide résistant aux rayons UV; acier inoxydable brossé	ABS, PMMA brillant, blanc, translucide résistant aux rayons UV; acier inoxydable brossé
Support de Lampe	1x E27/ max. 40 W E27	1x E27/ max. 40 W E27
Ampoule	luminant à DEL E27, max. 5,5 W, CÉ: F, max. 500 lm Durée de vie: 15.000 h	LED multicolours E27, max. 9 W, CÉ: F, max. 850 lm, Durée de vie: 50.000 h
Télécommande	-	avec télécommande radio
Batterie/ Temps de Charge Autonomie (en changement de couleur)	-	-
Chargeur	-	-
Câblage	env. 2,5 - 3 m, transparent	env. 2,5 - 3 m, transparent
Tension	200-240 VAC, 50 Hz	200-240 VAC, 50 Hz / MAX. 15 W
Catégorie	II	II
Pour Utilisation Intérieure	Oui	Oui
Pour Utilisation Extérieure	-	-

STUDIO OUTDOOR

36: 16-03-01 45: 16-03-02
75: 16-03-03 105: 16-03-04



ca. | approx. | env. 70x100 H 36/45/75/105 cm
ca. | approx. | env. 34.9/35.7/38.6/41.6 kg

ABS, PMMA glänzend, weiß transluzent,
UV-beständig; Edelstahl gebürstet

1x E27/ max. 40 W E27

LED Leuchtmittel E27,
max. 5,5 W, EEC: F, max. 500 lm
Lebensdauer: 15.000 h

-

-

-

-

ca. 3,5 - 4 m, schwarz

230 V~, 50 Hz

II

-

IP44

STUDIO OUTDOOR LED

36: 16-03-01 LED 45: 16-03-02 LED
75: 16-05-03 LED 105: 16-05-04 LED



ca. | approx. | env. 70x100 H 36/45/75/105 cm
ca. | approx. | env. 34.9/35.7/38.6/41.6 kg

ABS, PMMA glänzend, weiß transluzent,
UV-beständig; Edelstahl gebürstet

1x E27/ max. 40 W E27

Multicolor LED Leuchtmittel E27,
max. 9 W, EEC: F, max. 850 lm
Lebensdauer: 50.000 h

mit Funkfernbedienung

-

-

-

ca. 3,5 - 4 m, schwarz

230 V~, 50 Hz

II

-

IP44

STUDIO LED ACCU OUTDOOR

36: 16-08-01 45: 16-08-02
75: 16-08-03 105: 16-08-04



ca. | approx. | env. 70x100 H 36/45/75/105 cm
ca. | approx. | env. 34.9/35.7/38.6/41.6 kg

ABS, PMMA glänzend, weiß transluzent,
UV-beständig; Edelstahl gebürstet

Eingebaute LED-Einheit (ausbaubar)

Multicolor & Warmweiß 2700 K,
Kaltweiß 6000 K LEDs, max. 7.2 W,
max. 810 lm, Lebensdauer: 30000 h

IR

3.7 V, 2 x 2600 mAh (Li-Ion)/ 10 h
11 h

100-240 V~, 50/60 Hz, Vout 5 V, 1,2 A

1,2 m

100-240 VAC, 50/ 60 Hz

III (Produkt), II (Ladegerät)

-

IP54

ABS, PMMA glossy, white translucent
UV resistant; Stainless steel brushed

1x E27/ max. 40 W E27

LED bulb E27,
max. 5,5 W, EEC: F, max. 500 lm
Life span: 15.000 h

-

-

-

-

3,5 -4 m, black

230 V~, 50 Hz

II

-

IP44

ABS, PMMA glossy, white translucent
UV resistant; Stainless steel brushed

1x E27/ max. 40 W E27

LED multicolour light bulb E27,
max. 9 W, EEC: F, max. 850 lm,
Life span: 50.000 h

with Radio remote control

-

-

-

approx. 3.5-4 m, black

230 V~, 50 Hz

II

-

IP44

ABS, PMMA glossy, white translucent
UV resistant; Stainless steel brushed

Built-In LED Unit (removable)

Multicolor & warm white 2700 K,
cool white 6000 K LEDs, max. 7.2 W,
max. 810 lm, life span: 30000 h

IR

3.7 V, 2 x 2600 mAh (Li-Ion)/ 10 h
11 h

100-240 V~, 50/60 Hz, Vout 5 V, 1,2 A

1,2 m

100-240 VAC, 50/ 60 Hz

III (Product), II (Charger)

-

IP54

ABS, PMMA brillant, blanc, translucide
résistant aux rayons UV;
acier inoxydable brossé

1x E27/ max. 40 W E27

illuminant à DEL E27,
max. 5,5 W, CÉ: F, max. 500 lm
Durée de vie: 15.000 h

-

-

-

-

env. 3,5 - 4 m, noir

230 V~, 50 Hz

II

-

IP44

ABS, PMMA brillant, blanc, translucide
résistant aux rayons UV;
acier inoxydable brossé

1x E27/ max. 40 W E27

LED multicolores E27,
max. 9 W, CÉ: F, max. 850 lm,
Durée de vie: 50.000 h

avec télécommande radio

-

-

-

env. 3,5 - 4 m, noir

230 V~, 50 Hz

II

-

IP44

ABS, PMMA brillant, blanc, translucide
résistant aux rayons UV;
acier inoxydable brossé

Unité à LED intégrée (amovible)

DEL multicolores & blanc chaud 2700
K, blanc froid 6000 K, max. 7,2 W,
max. 810 lm, durée de vie: 30000 h

IR

3.7 V, 2 x 2600 mAh (Li-Ion)/ 10 h
11 h

100-240 V~, 50/60 Hz, Vout 5 V, 1,2 A

1,2 m

100-240 VAC, 50/ 60 Hz

III (Objet), II (Chargeur)

-

IP54

CUBE



Zubehör: Glasplatte oder Sitzkissen
 Accessory: Glass top or cushion
 Accessoire: Plaque de verre ou coussin









CUBE INDOOR

06-05-01

CUBE INDOOR LED

06-05-01-LED

Modell | Model | Modèle

	  	    
Maße Dimensions Dimensions	ca. approx. env. 44 x 44 x 45 cm	ca. approx. env. 44 x 44 x 45 cm
Gewicht Weight Poids	ca. approx. env. 6 kg	ca. approx. env. 6 kg
DE Material	PE seidenmatt, UV-beständig	PE seidenmatt, UV-beständig
Farbe	Weiß, transluzent	Weiß, transluzent
Lampenfassung	1x E27/ max. 40 W E27	1x E27/ max. 40 W E27
Leuchtmittel	LED Leuchtmittel E27, max. 5,5 W, EEC: F, max. 500 lm Lebensdauer: 15.000 h	Multicolor LED Leuchtmittel E27, max. 9 W, EEC: F, max. 850 lm Lebensdauer: 50.000 h
Fernbedienung	-	mit Funkfernbedienung
Aufladbarer Akku/ Ladezeit Laufzeit (in Farbwechsel)	-	-
Ladegerät	-	-
Verkabelung	ca. 3 m mit Fußschalter, klar	ca. 3 m mit Fußschalter, klar
Spannung	230 V~, 50Hz	230 V~, 50Hz
Schutzklasse	II	II
Für Innenbereich	Ja	Ja
Für Aussenbereich	-	-
EN Material	PE semi gloss, UV resistant	PE semi gloss, UV resistant
Colour	White, translucent	White, translucent
Lamp Holder	1x E27/ max. 40 W E27	1x E27/ max. 40 W E27
Illuminant	LED bulb E27, max. 5,5 W, EEC: F, max. 500 lm Life span: 15.000 h	LED multicolour light bulb E27, max. 9 W, EEC: F, max. 850 lm, Life span: 50.000 h
Remote Control	-	with Radio remote control
Rechargeable battery/ Charging Time Runtime (in colour change)	-	-
Charger	-	-
Cable	approx. 3 m with foot switch, clear	approx. 3 m with foot switch, clear
Voltage	230 V~, 50 Hz	230 V~, 50Hz
Protection Class	II	II
For Indoor Use	Yes	Yes
For Outdoor Use	-	-
FR Matériaux	PE satiné, résistant aux rayons UV	PE satiné, résistant aux rayons UV
Couleur	Blanc, translucide	Blanc, translucide
Support de Lampe	1x E27/ max. 40 W E27	1x E27/ max. 40 W E27
Ampoule	Illuminant à DEL E27, max. 5,5 W, CÉ: F, max. 500 lm Durée de vie: 15.000 h	LED multicolours E27, max. 9 W, CÉ: F, max. 850 lm, Durée de vie: 50.000 h
Télécommande	-	avec télécommande radio
Batterie/ Temps de Charge Autonomie (en changement de couleur)	-	-
Chargeur	-	-
Câblage	env. 3 m avec pédale, transparent	env. 3 m avec pédale, transparent
Tension	230 V~, 50 Hz	230 V~, 50Hz
Catégorie	II	II
Pour Utilisation Intérieur	Oui	Oui
Pour Utilisation Extérieure	-	-

CUBE OUTDOOR

06-06-01



ca. | approx. | env. 44 x 44 x 45 cm

ca. | approx. | env. 6.5 kg

PE seidenmatt, UV-beständig
Weiß, transluzent
1x E27/ max. 40 W E27
LED Leuchtmittel E27, max. 5,5 W, EEC: F, max. 500 lm
Lebensdauer: 15.000 h
-
-
-
ca. 5 m, schwarz
230 V~, 50 Hz
II
-
IP44

PE semi gloss, UV resistant
White, translucent
1x E27/ max. 40 W E27
LED bulb E27, max. 5,5 W, EEC: F, max. 500 lm
Life span: 15.000 h
-
-
-
approx. 5 m, black
230 V~, 50 Hz
II
-
IP44

PE satiné, résistant aux rayons UV
Blanc, translucide
1x E27/ max. 40 W E27
illuminant à DEL E27, max. 5,5 W, CE: F, max. 500 lm
Durée de vie: 15.000 h
-
-
-
env. 5 m, noir
230 V~, 50 Hz
II
-
IP44

CUBE OUTDOOR LED

06-06-01-LED



ca. | approx. | env. 44 x 44 x 45 cm

ca. | approx. | env. 6.5 kg

PE seidenmatt, UV-beständig
Weiß, transluzent
1x E27/ max. 40 W E27
Multicolor LED Leuchtmittel E27, max. 9 W, EEC: F, max. 850 lm
Lebensdauer: 50.000 h
mit Funkfernbedienung
-
-
-
ca. 5 m, schwarz
230 V~, 50 Hz
II
-
IP44

PE semi gloss, UV resistant
White, translucent
1x E27/ max. 40 W E27
LED multicolour light bulb E27, max. 9 W, EEC: F, max. 850 lm, Life span: 50.000 h
with Radio remote control
-
-
-
approx. 5 m, black
230 V~, 50 Hz
II
-
IP44

PE satiné, résistant aux rayons UV
Blanc, translucide
1x E27/ max. 40 W E27
LED multicolours E27, max. 9 W, CE: F, max. 850 lm, Durée de vie: 50.000 h
avec télécommande radio
-
-
-
env. 5 m, noir
230 V~, 50 Hz
II
-
IP44

CUBE LED ACCU OUTDOOR

09-01-04



ca. | approx. | env. 44 x 44 x 45 cm

ca. | approx. | env. 6 kg

PE seidenmatt, UV-beständig
Weiß, transluzent
Eingebaute LED-Einheit (ausbaubar)
Multicolor & Warmweiß 2700 K, Kaltweiß 6000 K LEDs, max. 7,2 W, max. 810 lm, Lebensdauer: 30000 h
IR
3,7 V, 2 x 2600 mAh (Li-Ion)/ 10 h 11 h
-
-
100-240 V~, 50/60 Hz, Vout 5 V, 1,2 A
1,2 m
100-240 VAC, 50/ 60 Hz
III (Produkt), II (Ladegerät)
-
IP54

PE semi gloss, UV resistant
White, translucent
Built-In LED Unit (removable)
Multicolor & warm white 2700 K, cool white 6000 K LEDs, max. 7,2 W, max. 810 lm, life span: 30000 h
IR
3,7 V, 2 x 2600 mAh (Li-Ion)/ 10 h 11 h
-
-
100-240 V~, 50/60 Hz, Vout 5 V, 1,2 A
1,2 m
100-240 VAC, 50/ 60 Hz
III (Product), II (Charger)
-
IP54

PE satiné, résistant aux rayons UV
Blanc, translucide
Unité à LED intégrée (amovible)
DEL multicolores & blanc chaud 2700 K, blanc froid 6000 K, max. 7,2 W, max. 810 lm, durée de vie: 30000 h
IR
3,7 V, 2 x 2600 mAh (Li-Ion)/ 10 h 11 h
-
-
100-240 V~, 50/60 Hz, Vout 5 V, 1,2 A
1,2 m
100-240 VAC, 50/ 60 Hz
III (Produit), II (Chargeur)
-
IP54

CUBE CUSHIONS & GLASSTOP



Modell	06-09-06 Sitzkissen Orange
	06-09-05 Sitzkissen Rot
	06-09-04 Sitzkissen Violett
	06-09-03 Sitzkissen Grün
	06-09-02 Sitzkissen Anthrazit
Material	Filz, 100% Wolle
Maße	B 40 x L 40 x H 0,5 cm
Gewicht	ca. 0.2 kg
Modell	06-09-01 Glastischplatte
Material	Sicherheitsglas, klar
Maße	B 40 x L 40 x H 0,5 cm
Gewicht	2,2 kg

Model	06-09-06 Orange cushion
	06-09-05 Red cushion
	06-09-04 Purple cushion
	06-09-03 Green cushion
	06-09-02 Anthracite cushion
Material	Felt, 100% wool
Dims	L 40 x W 40 x H 0.5 cm
Weight	approx. 0.2 kg
Model	06-09-01 Glasstop
Material	Safety glass, transparent
Dims	L 40 x W 40 x H 0.5 cm
Weight	2,2 kg

Modèle	06-09-06 Orange coussin
	06-09-05 Rouge coussin
	06-09-04 Pourpre coussin
	06-09-03 Vert coussin
	06-09-02 Anthracite coussin
Matériaux	Feutre, 100% laine
Dims	Lo 40 x La 40 x H 0.5 cm
Poids	env. 0.2 kg
Modèle	06-09-01 Panneau de verre
Matériaux	Verre de sécurité, transparent
Dims	Lo 40 x La 40 x H 0.5 cm
Poids	2,2 kg

COOLER



LED-Akku-Einheit
entnehmbar zum Laden
LED battery unit
removable for charging
Unité de batterie LED amovible
pour le chargement

Modell Model Modèle	COOLER LED ACCU OUTDOOR 14-01-02	COOLER 70LED ACCU OUTDOOR 14-01-01																																																																																										
DE	<table border="1"> <tr><td>Material</td><td>PE seidenmatt, UV-beständig</td><td>PE seidenmatt, UV-beständig</td></tr> <tr><td>Farbe</td><td>weiß, transluzent</td><td>weiß, transluzent</td></tr> <tr><td>Maße</td><td>ca. Ø 46 cm, H 89 cm</td><td>Ø 35 cm, H 70 cm</td></tr> <tr><td>Gewicht</td><td>ca. 10 kg</td><td>4,8 kg</td></tr> <tr><td>Lampenfassung</td><td>LED-Einheit entnehmbar zum Laden</td><td>LED-Einheit entnehmbar zum Laden</td></tr> <tr><td>Leuchtmittel</td><td>Multicolor & Warmweiß 2700 K, Kaltweiß 6000 K LEDs, max. 7.2 W, max. 810 lm, Lebensdauer: 30000 h</td><td>Multicolor & Warmweiß 2700 K, Kaltweiß 6000 K LEDs, max. 7.2 W, max. 810 lm, Lebensdauer: 30000 h</td></tr> <tr><td>Fernbedienung</td><td>IR</td><td>IR</td></tr> <tr><td>Aufladbarer Akku/ Ladezeit</td><td>3.7 V, 2 x 2600 mAh (Li-Ion)/ 10 h</td><td>3.7 V, 2 x 2600 mAh (Li-Ion)/ 10 h</td></tr> <tr><td>Laufzeit (in Farbwechsel)</td><td>11 h</td><td>11 h</td></tr> <tr><td>Ladegerät</td><td>100-240 V~, 50/60 Hz, Vout 5 V, 1,2 A</td><td>100-240 V~, 50/60 Hz, Vout 5 V, 1,2 A</td></tr> <tr><td>Verkabelung</td><td>1,2 m</td><td>1,2 m</td></tr> <tr><td>Spannung</td><td>100-240 VAC, 50/ 60 Hz</td><td>100-240 VAC, 50/ 60 Hz</td></tr> <tr><td>Schutzklasse</td><td>III (Produkt), II (Ladegerät)</td><td>III (Produkt), II (Ladegerät)</td></tr> <tr><td>Getränke-Einsatz (herausnehmbar)</td><td>-</td><td>Ø 230/200 mm, H 175 mm, PP</td></tr> <tr><td>Für Aussenbereich</td><td>IP54</td><td>IP54</td></tr> </table>	Material	PE seidenmatt, UV-beständig	PE seidenmatt, UV-beständig	Farbe	weiß, transluzent	weiß, transluzent	Maße	ca. Ø 46 cm, H 89 cm	Ø 35 cm, H 70 cm	Gewicht	ca. 10 kg	4,8 kg	Lampenfassung	LED-Einheit entnehmbar zum Laden	LED-Einheit entnehmbar zum Laden	Leuchtmittel	Multicolor & Warmweiß 2700 K, Kaltweiß 6000 K LEDs, max. 7.2 W, max. 810 lm, Lebensdauer: 30000 h	Multicolor & Warmweiß 2700 K, Kaltweiß 6000 K LEDs, max. 7.2 W, max. 810 lm, Lebensdauer: 30000 h	Fernbedienung	IR	IR	Aufladbarer Akku/ Ladezeit	3.7 V, 2 x 2600 mAh (Li-Ion)/ 10 h	3.7 V, 2 x 2600 mAh (Li-Ion)/ 10 h	Laufzeit (in Farbwechsel)	11 h	11 h	Ladegerät	100-240 V~, 50/60 Hz, Vout 5 V, 1,2 A	100-240 V~, 50/60 Hz, Vout 5 V, 1,2 A	Verkabelung	1,2 m	1,2 m	Spannung	100-240 VAC, 50/ 60 Hz	100-240 VAC, 50/ 60 Hz	Schutzklasse	III (Produkt), II (Ladegerät)	III (Produkt), II (Ladegerät)	Getränke-Einsatz (herausnehmbar)	-	Ø 230/200 mm, H 175 mm, PP	Für Aussenbereich	IP54	IP54	<table border="1"> <tr><td>Material</td><td>PE seidenmatt, UV-beständig</td><td>PE seidenmatt, UV-beständig</td></tr> <tr><td>Farbe</td><td>weiß, transluzent</td><td>weiß, transluzent</td></tr> <tr><td>Maße</td><td>ca. Ø 46 cm, H 89 cm</td><td>Ø 35 cm, H 70 cm</td></tr> <tr><td>Gewicht</td><td>ca. 10 kg</td><td>4,8 kg</td></tr> <tr><td>Lampenfassung</td><td>LED-Einheit entnehmbar zum Laden</td><td>LED-Einheit entnehmbar zum Laden</td></tr> <tr><td>Leuchtmittel</td><td>Multicolor & Warmweiß 2700 K, Kaltweiß 6000 K LEDs, max. 7.2 W, max. 810 lm, Lebensdauer: 30000 h</td><td>Multicolor & Warmweiß 2700 K, Kaltweiß 6000 K LEDs, max. 7.2 W, max. 810 lm, Lebensdauer: 30000 h</td></tr> <tr><td>Fernbedienung</td><td>IR</td><td>IR</td></tr> <tr><td>Aufladbarer Akku/ Ladezeit</td><td>3.7 V, 2 x 2600 mAh (Li-Ion)/ 10 h</td><td>3.7 V, 2 x 2600 mAh (Li-Ion)/ 10 h</td></tr> <tr><td>Laufzeit (in Farbwechsel)</td><td>11 h</td><td>11 h</td></tr> <tr><td>Ladegerät</td><td>100-240 V~, 50/60 Hz, Vout 5 V, 1,2 A</td><td>100-240 V~, 50/60 Hz, Vout 5 V, 1,2 A</td></tr> <tr><td>Verkabelung</td><td>1,2 m</td><td>1,2 m</td></tr> <tr><td>Spannung</td><td>100-240 VAC, 50/ 60 Hz</td><td>100-240 VAC, 50/ 60 Hz</td></tr> <tr><td>Schutzklasse</td><td>III (Produkt), II (Ladegerät)</td><td>III (Produkt), II (Ladegerät)</td></tr> <tr><td>Getränke-Einsatz (herausnehmbar)</td><td>-</td><td>Ø 230/200 mm, H 175 mm, PP</td></tr> <tr><td>Für Aussenbereich</td><td>IP54</td><td>IP54</td></tr> </table>	Material	PE seidenmatt, UV-beständig	PE seidenmatt, UV-beständig	Farbe	weiß, transluzent	weiß, transluzent	Maße	ca. Ø 46 cm, H 89 cm	Ø 35 cm, H 70 cm	Gewicht	ca. 10 kg	4,8 kg	Lampenfassung	LED-Einheit entnehmbar zum Laden	LED-Einheit entnehmbar zum Laden	Leuchtmittel	Multicolor & Warmweiß 2700 K, Kaltweiß 6000 K LEDs, max. 7.2 W, max. 810 lm, Lebensdauer: 30000 h	Multicolor & Warmweiß 2700 K, Kaltweiß 6000 K LEDs, max. 7.2 W, max. 810 lm, Lebensdauer: 30000 h	Fernbedienung	IR	IR	Aufladbarer Akku/ Ladezeit	3.7 V, 2 x 2600 mAh (Li-Ion)/ 10 h	3.7 V, 2 x 2600 mAh (Li-Ion)/ 10 h	Laufzeit (in Farbwechsel)	11 h	11 h	Ladegerät	100-240 V~, 50/60 Hz, Vout 5 V, 1,2 A	100-240 V~, 50/60 Hz, Vout 5 V, 1,2 A	Verkabelung	1,2 m	1,2 m	Spannung	100-240 VAC, 50/ 60 Hz	100-240 VAC, 50/ 60 Hz	Schutzklasse	III (Produkt), II (Ladegerät)	III (Produkt), II (Ladegerät)	Getränke-Einsatz (herausnehmbar)	-	Ø 230/200 mm, H 175 mm, PP	Für Aussenbereich	IP54	IP54
Material	PE seidenmatt, UV-beständig	PE seidenmatt, UV-beständig																																																																																										
Farbe	weiß, transluzent	weiß, transluzent																																																																																										
Maße	ca. Ø 46 cm, H 89 cm	Ø 35 cm, H 70 cm																																																																																										
Gewicht	ca. 10 kg	4,8 kg																																																																																										
Lampenfassung	LED-Einheit entnehmbar zum Laden	LED-Einheit entnehmbar zum Laden																																																																																										
Leuchtmittel	Multicolor & Warmweiß 2700 K, Kaltweiß 6000 K LEDs, max. 7.2 W, max. 810 lm, Lebensdauer: 30000 h	Multicolor & Warmweiß 2700 K, Kaltweiß 6000 K LEDs, max. 7.2 W, max. 810 lm, Lebensdauer: 30000 h																																																																																										
Fernbedienung	IR	IR																																																																																										
Aufladbarer Akku/ Ladezeit	3.7 V, 2 x 2600 mAh (Li-Ion)/ 10 h	3.7 V, 2 x 2600 mAh (Li-Ion)/ 10 h																																																																																										
Laufzeit (in Farbwechsel)	11 h	11 h																																																																																										
Ladegerät	100-240 V~, 50/60 Hz, Vout 5 V, 1,2 A	100-240 V~, 50/60 Hz, Vout 5 V, 1,2 A																																																																																										
Verkabelung	1,2 m	1,2 m																																																																																										
Spannung	100-240 VAC, 50/ 60 Hz	100-240 VAC, 50/ 60 Hz																																																																																										
Schutzklasse	III (Produkt), II (Ladegerät)	III (Produkt), II (Ladegerät)																																																																																										
Getränke-Einsatz (herausnehmbar)	-	Ø 230/200 mm, H 175 mm, PP																																																																																										
Für Aussenbereich	IP54	IP54																																																																																										
Material	PE seidenmatt, UV-beständig	PE seidenmatt, UV-beständig																																																																																										
Farbe	weiß, transluzent	weiß, transluzent																																																																																										
Maße	ca. Ø 46 cm, H 89 cm	Ø 35 cm, H 70 cm																																																																																										
Gewicht	ca. 10 kg	4,8 kg																																																																																										
Lampenfassung	LED-Einheit entnehmbar zum Laden	LED-Einheit entnehmbar zum Laden																																																																																										
Leuchtmittel	Multicolor & Warmweiß 2700 K, Kaltweiß 6000 K LEDs, max. 7.2 W, max. 810 lm, Lebensdauer: 30000 h	Multicolor & Warmweiß 2700 K, Kaltweiß 6000 K LEDs, max. 7.2 W, max. 810 lm, Lebensdauer: 30000 h																																																																																										
Fernbedienung	IR	IR																																																																																										
Aufladbarer Akku/ Ladezeit	3.7 V, 2 x 2600 mAh (Li-Ion)/ 10 h	3.7 V, 2 x 2600 mAh (Li-Ion)/ 10 h																																																																																										
Laufzeit (in Farbwechsel)	11 h	11 h																																																																																										
Ladegerät	100-240 V~, 50/60 Hz, Vout 5 V, 1,2 A	100-240 V~, 50/60 Hz, Vout 5 V, 1,2 A																																																																																										
Verkabelung	1,2 m	1,2 m																																																																																										
Spannung	100-240 VAC, 50/ 60 Hz	100-240 VAC, 50/ 60 Hz																																																																																										
Schutzklasse	III (Produkt), II (Ladegerät)	III (Produkt), II (Ladegerät)																																																																																										
Getränke-Einsatz (herausnehmbar)	-	Ø 230/200 mm, H 175 mm, PP																																																																																										
Für Aussenbereich	IP54	IP54																																																																																										
EN	<table border="1"> <tr><td>Material</td><td>PE semi gloss, UV resistant</td><td>PE semi gloss, UV resistant</td></tr> <tr><td>Colour</td><td>white, translucent</td><td>white, translucent</td></tr> <tr><td>Dimensions</td><td>approx. ca. Ø 46 cm, H 89 cm</td><td>Ø 35 cm, H 70 cm</td></tr> <tr><td>Weight</td><td>approx. 10 kg</td><td>4.8 kg</td></tr> <tr><td>Lamp Holder</td><td>LED unit removable for charging</td><td>LED unit removable for charging</td></tr> <tr><td>Illuminant</td><td>Multicolor & warm white 2700 K, cool white 6000 K LEDs, max. 7.2 W, max. 810 lm, life span: 30000 h</td><td>Multicolor & warm white 2700 K, cool white 6000 K LEDs, max. 7.2 W, max. 810 lm, life span: 30000 h</td></tr> <tr><td>Remote Control</td><td>IR</td><td>IR</td></tr> <tr><td>Rechargeable battery/ ChargingTime</td><td>3.7 V, 2 x 2600 mAh (Li-Ion)/ 10 h</td><td>3.7 V, 2 x 2600 mAh (Li-Ion)/ 10 h</td></tr> <tr><td>Runtime (in colour change)</td><td>11 h</td><td>11 h</td></tr> <tr><td>Charger</td><td>100-240 V~, 50/60 Hz, Vout 5 V, 1,2 A</td><td>100-240 V~, 50/60 Hz, Vout 5 V, 1,2 A</td></tr> <tr><td>Cable</td><td>1,2 m</td><td>1,2 m</td></tr> <tr><td>Voltage</td><td>100-240 VAC, 50/ 60 Hz</td><td>100-240 VAC, 50/ 60 Hz</td></tr> <tr><td>Protection Class</td><td>III (Product), II (Charger)</td><td>III (Product), II (Charger)</td></tr> <tr><td>Beverage insert (removable)</td><td>-</td><td>Ø 230/200 mm, H 175 mm, PP</td></tr> <tr><td>For Outdoor Use</td><td>IP54</td><td>IP54</td></tr> </table>	Material	PE semi gloss, UV resistant	PE semi gloss, UV resistant	Colour	white, translucent	white, translucent	Dimensions	approx. ca. Ø 46 cm, H 89 cm	Ø 35 cm, H 70 cm	Weight	approx. 10 kg	4.8 kg	Lamp Holder	LED unit removable for charging	LED unit removable for charging	Illuminant	Multicolor & warm white 2700 K, cool white 6000 K LEDs, max. 7.2 W, max. 810 lm, life span: 30000 h	Multicolor & warm white 2700 K, cool white 6000 K LEDs, max. 7.2 W, max. 810 lm, life span: 30000 h	Remote Control	IR	IR	Rechargeable battery/ ChargingTime	3.7 V, 2 x 2600 mAh (Li-Ion)/ 10 h	3.7 V, 2 x 2600 mAh (Li-Ion)/ 10 h	Runtime (in colour change)	11 h	11 h	Charger	100-240 V~, 50/60 Hz, Vout 5 V, 1,2 A	100-240 V~, 50/60 Hz, Vout 5 V, 1,2 A	Cable	1,2 m	1,2 m	Voltage	100-240 VAC, 50/ 60 Hz	100-240 VAC, 50/ 60 Hz	Protection Class	III (Product), II (Charger)	III (Product), II (Charger)	Beverage insert (removable)	-	Ø 230/200 mm, H 175 mm, PP	For Outdoor Use	IP54	IP54	<table border="1"> <tr><td>Material</td><td>PE semi gloss, UV resistant</td><td>PE semi gloss, UV resistant</td></tr> <tr><td>Colour</td><td>white, translucent</td><td>white, translucent</td></tr> <tr><td>Dimensions</td><td>approx. ca. Ø 46 cm, H 89 cm</td><td>Ø 35 cm, H 70 cm</td></tr> <tr><td>Weight</td><td>approx. 10 kg</td><td>4.8 kg</td></tr> <tr><td>Lamp Holder</td><td>LED unit removable for charging</td><td>LED unit removable for charging</td></tr> <tr><td>Illuminant</td><td>Multicolor & warm white 2700 K, cool white 6000 K LEDs, max. 7.2 W, max. 810 lm, life span: 30000 h</td><td>Multicolor & warm white 2700 K, cool white 6000 K LEDs, max. 7.2 W, max. 810 lm, life span: 30000 h</td></tr> <tr><td>Remote Control</td><td>IR</td><td>IR</td></tr> <tr><td>Rechargeable battery/ ChargingTime</td><td>3.7 V, 2 x 2600 mAh (Li-Ion)/ 10 h</td><td>3.7 V, 2 x 2600 mAh (Li-Ion)/ 10 h</td></tr> <tr><td>Runtime (in colour change)</td><td>11 h</td><td>11 h</td></tr> <tr><td>Charger</td><td>100-240 V~, 50/60 Hz, Vout 5 V, 1,2 A</td><td>100-240 V~, 50/60 Hz, Vout 5 V, 1,2 A</td></tr> <tr><td>Cable</td><td>1,2 m</td><td>1,2 m</td></tr> <tr><td>Voltage</td><td>100-240 VAC, 50/ 60 Hz</td><td>100-240 VAC, 50/ 60 Hz</td></tr> <tr><td>Protection Class</td><td>III (Product), II (Charger)</td><td>III (Product), II (Charger)</td></tr> <tr><td>Beverage insert (removable)</td><td>-</td><td>Ø 230/200 mm, H 175 mm, PP</td></tr> <tr><td>For Outdoor Use</td><td>IP54</td><td>IP54</td></tr> </table>	Material	PE semi gloss, UV resistant	PE semi gloss, UV resistant	Colour	white, translucent	white, translucent	Dimensions	approx. ca. Ø 46 cm, H 89 cm	Ø 35 cm, H 70 cm	Weight	approx. 10 kg	4.8 kg	Lamp Holder	LED unit removable for charging	LED unit removable for charging	Illuminant	Multicolor & warm white 2700 K, cool white 6000 K LEDs, max. 7.2 W, max. 810 lm, life span: 30000 h	Multicolor & warm white 2700 K, cool white 6000 K LEDs, max. 7.2 W, max. 810 lm, life span: 30000 h	Remote Control	IR	IR	Rechargeable battery/ ChargingTime	3.7 V, 2 x 2600 mAh (Li-Ion)/ 10 h	3.7 V, 2 x 2600 mAh (Li-Ion)/ 10 h	Runtime (in colour change)	11 h	11 h	Charger	100-240 V~, 50/60 Hz, Vout 5 V, 1,2 A	100-240 V~, 50/60 Hz, Vout 5 V, 1,2 A	Cable	1,2 m	1,2 m	Voltage	100-240 VAC, 50/ 60 Hz	100-240 VAC, 50/ 60 Hz	Protection Class	III (Product), II (Charger)	III (Product), II (Charger)	Beverage insert (removable)	-	Ø 230/200 mm, H 175 mm, PP	For Outdoor Use	IP54	IP54
Material	PE semi gloss, UV resistant	PE semi gloss, UV resistant																																																																																										
Colour	white, translucent	white, translucent																																																																																										
Dimensions	approx. ca. Ø 46 cm, H 89 cm	Ø 35 cm, H 70 cm																																																																																										
Weight	approx. 10 kg	4.8 kg																																																																																										
Lamp Holder	LED unit removable for charging	LED unit removable for charging																																																																																										
Illuminant	Multicolor & warm white 2700 K, cool white 6000 K LEDs, max. 7.2 W, max. 810 lm, life span: 30000 h	Multicolor & warm white 2700 K, cool white 6000 K LEDs, max. 7.2 W, max. 810 lm, life span: 30000 h																																																																																										
Remote Control	IR	IR																																																																																										
Rechargeable battery/ ChargingTime	3.7 V, 2 x 2600 mAh (Li-Ion)/ 10 h	3.7 V, 2 x 2600 mAh (Li-Ion)/ 10 h																																																																																										
Runtime (in colour change)	11 h	11 h																																																																																										
Charger	100-240 V~, 50/60 Hz, Vout 5 V, 1,2 A	100-240 V~, 50/60 Hz, Vout 5 V, 1,2 A																																																																																										
Cable	1,2 m	1,2 m																																																																																										
Voltage	100-240 VAC, 50/ 60 Hz	100-240 VAC, 50/ 60 Hz																																																																																										
Protection Class	III (Product), II (Charger)	III (Product), II (Charger)																																																																																										
Beverage insert (removable)	-	Ø 230/200 mm, H 175 mm, PP																																																																																										
For Outdoor Use	IP54	IP54																																																																																										
Material	PE semi gloss, UV resistant	PE semi gloss, UV resistant																																																																																										
Colour	white, translucent	white, translucent																																																																																										
Dimensions	approx. ca. Ø 46 cm, H 89 cm	Ø 35 cm, H 70 cm																																																																																										
Weight	approx. 10 kg	4.8 kg																																																																																										
Lamp Holder	LED unit removable for charging	LED unit removable for charging																																																																																										
Illuminant	Multicolor & warm white 2700 K, cool white 6000 K LEDs, max. 7.2 W, max. 810 lm, life span: 30000 h	Multicolor & warm white 2700 K, cool white 6000 K LEDs, max. 7.2 W, max. 810 lm, life span: 30000 h																																																																																										
Remote Control	IR	IR																																																																																										
Rechargeable battery/ ChargingTime	3.7 V, 2 x 2600 mAh (Li-Ion)/ 10 h	3.7 V, 2 x 2600 mAh (Li-Ion)/ 10 h																																																																																										
Runtime (in colour change)	11 h	11 h																																																																																										
Charger	100-240 V~, 50/60 Hz, Vout 5 V, 1,2 A	100-240 V~, 50/60 Hz, Vout 5 V, 1,2 A																																																																																										
Cable	1,2 m	1,2 m																																																																																										
Voltage	100-240 VAC, 50/ 60 Hz	100-240 VAC, 50/ 60 Hz																																																																																										
Protection Class	III (Product), II (Charger)	III (Product), II (Charger)																																																																																										
Beverage insert (removable)	-	Ø 230/200 mm, H 175 mm, PP																																																																																										
For Outdoor Use	IP54	IP54																																																																																										
FR	<table border="1"> <tr><td>Matériaux</td><td>PE satiné, résistant aux rayons UV</td><td>PE satiné, résistant aux rayons UV</td></tr> <tr><td>Couleur</td><td>blanc, translucide</td><td>blanc, translucide</td></tr> <tr><td>Dimensions</td><td>env. Ø 46 cm, H 89 cm</td><td>Ø 35 cm, H 70 cm</td></tr> <tr><td>Poids</td><td>env. 10 kg</td><td>4,8 kg</td></tr> <tr><td>Support de Lampe</td><td>Unité LED amovible pour la charge</td><td>Unité LED amovible pour la charge</td></tr> <tr><td>Ampoule</td><td>DEL multicolores & blanc chaud 2700 K, blanc froid 6000 K, max. 7,2 W, max. 810 lm, durée de vie: 30000 h</td><td>DEL multicolores & blanc chaud 2700 K, blanc froid 6000 K, max. 7,2 W, max. 810 lm, durée de vie: 30000 h</td></tr> <tr><td>Télécommande</td><td>IR</td><td>IR</td></tr> <tr><td>Rechargeable battery/ ChargingTime</td><td>3.7 V, 2 x 2600 mAh (Li-Ion)/ 10 h</td><td>3.7 V, 2 x 2600 mAh (Li-Ion)/ 10 h</td></tr> <tr><td>Runtime (in colour change)</td><td>11 h</td><td>11 h</td></tr> <tr><td>Chargeur</td><td>100-240 V~, 50/60 Hz, Vout 5 V, 1,2 A</td><td>100-240 V~, 50/60 Hz, Vout 5 V, 1,2 A</td></tr> <tr><td>Câblage</td><td>1,2 m</td><td>1,2 m</td></tr> <tr><td>Tension</td><td>100-240 VAC, 50/ 60 Hz</td><td>100-240 VAC, 50/ 60 Hz</td></tr> <tr><td>Catégorie</td><td>III (Produit), II (Chargeur)</td><td>III (Produit), II (Chargeur)</td></tr> <tr><td>Insert pour boissons (amovible)</td><td>-</td><td>Ø 230/200 mm, H 175 mm, PP</td></tr> <tr><td>Pour Utilisation Extérieure</td><td>IP54</td><td>IP54</td></tr> </table>	Matériaux	PE satiné, résistant aux rayons UV	PE satiné, résistant aux rayons UV	Couleur	blanc, translucide	blanc, translucide	Dimensions	env. Ø 46 cm, H 89 cm	Ø 35 cm, H 70 cm	Poids	env. 10 kg	4,8 kg	Support de Lampe	Unité LED amovible pour la charge	Unité LED amovible pour la charge	Ampoule	DEL multicolores & blanc chaud 2700 K, blanc froid 6000 K, max. 7,2 W, max. 810 lm, durée de vie: 30000 h	DEL multicolores & blanc chaud 2700 K, blanc froid 6000 K, max. 7,2 W, max. 810 lm, durée de vie: 30000 h	Télécommande	IR	IR	Rechargeable battery/ ChargingTime	3.7 V, 2 x 2600 mAh (Li-Ion)/ 10 h	3.7 V, 2 x 2600 mAh (Li-Ion)/ 10 h	Runtime (in colour change)	11 h	11 h	Chargeur	100-240 V~, 50/60 Hz, Vout 5 V, 1,2 A	100-240 V~, 50/60 Hz, Vout 5 V, 1,2 A	Câblage	1,2 m	1,2 m	Tension	100-240 VAC, 50/ 60 Hz	100-240 VAC, 50/ 60 Hz	Catégorie	III (Produit), II (Chargeur)	III (Produit), II (Chargeur)	Insert pour boissons (amovible)	-	Ø 230/200 mm, H 175 mm, PP	Pour Utilisation Extérieure	IP54	IP54	<table border="1"> <tr><td>Matériaux</td><td>PE satiné, résistant aux rayons UV</td><td>PE satiné, résistant aux rayons UV</td></tr> <tr><td>Couleur</td><td>blanc, translucide</td><td>blanc, translucide</td></tr> <tr><td>Dimensions</td><td>env. Ø 46 cm, H 89 cm</td><td>Ø 35 cm, H 70 cm</td></tr> <tr><td>Poids</td><td>env. 10 kg</td><td>4,8 kg</td></tr> <tr><td>Support de Lampe</td><td>Unité LED amovible pour la charge</td><td>Unité LED amovible pour la charge</td></tr> <tr><td>Ampoule</td><td>DEL multicolores & blanc chaud 2700 K, blanc froid 6000 K, max. 7,2 W, max. 810 lm, durée de vie: 30000 h</td><td>DEL multicolores & blanc chaud 2700 K, blanc froid 6000 K, max. 7,2 W, max. 810 lm, durée de vie: 30000 h</td></tr> <tr><td>Télécommande</td><td>IR</td><td>IR</td></tr> <tr><td>Rechargeable battery/ ChargingTime</td><td>3.7 V, 2 x 2600 mAh (Li-Ion)/ 10 h</td><td>3.7 V, 2 x 2600 mAh (Li-Ion)/ 10 h</td></tr> <tr><td>Runtime (in colour change)</td><td>11 h</td><td>11 h</td></tr> <tr><td>Chargeur</td><td>100-240 V~, 50/60 Hz, Vout 5 V, 1,2 A</td><td>100-240 V~, 50/60 Hz, Vout 5 V, 1,2 A</td></tr> <tr><td>Câblage</td><td>1,2 m</td><td>1,2 m</td></tr> <tr><td>Tension</td><td>100-240 VAC, 50/ 60 Hz</td><td>100-240 VAC, 50/ 60 Hz</td></tr> <tr><td>Catégorie</td><td>III (Produit), II (Chargeur)</td><td>III (Produit), II (Chargeur)</td></tr> <tr><td>Insert pour boissons (amovible)</td><td>-</td><td>Ø 230/200 mm, H 175 mm, PP</td></tr> <tr><td>Pour Utilisation Extérieure</td><td>IP54</td><td>IP54</td></tr> </table>	Matériaux	PE satiné, résistant aux rayons UV	PE satiné, résistant aux rayons UV	Couleur	blanc, translucide	blanc, translucide	Dimensions	env. Ø 46 cm, H 89 cm	Ø 35 cm, H 70 cm	Poids	env. 10 kg	4,8 kg	Support de Lampe	Unité LED amovible pour la charge	Unité LED amovible pour la charge	Ampoule	DEL multicolores & blanc chaud 2700 K, blanc froid 6000 K, max. 7,2 W, max. 810 lm, durée de vie: 30000 h	DEL multicolores & blanc chaud 2700 K, blanc froid 6000 K, max. 7,2 W, max. 810 lm, durée de vie: 30000 h	Télécommande	IR	IR	Rechargeable battery/ ChargingTime	3.7 V, 2 x 2600 mAh (Li-Ion)/ 10 h	3.7 V, 2 x 2600 mAh (Li-Ion)/ 10 h	Runtime (in colour change)	11 h	11 h	Chargeur	100-240 V~, 50/60 Hz, Vout 5 V, 1,2 A	100-240 V~, 50/60 Hz, Vout 5 V, 1,2 A	Câblage	1,2 m	1,2 m	Tension	100-240 VAC, 50/ 60 Hz	100-240 VAC, 50/ 60 Hz	Catégorie	III (Produit), II (Chargeur)	III (Produit), II (Chargeur)	Insert pour boissons (amovible)	-	Ø 230/200 mm, H 175 mm, PP	Pour Utilisation Extérieure	IP54	IP54
Matériaux	PE satiné, résistant aux rayons UV	PE satiné, résistant aux rayons UV																																																																																										
Couleur	blanc, translucide	blanc, translucide																																																																																										
Dimensions	env. Ø 46 cm, H 89 cm	Ø 35 cm, H 70 cm																																																																																										
Poids	env. 10 kg	4,8 kg																																																																																										
Support de Lampe	Unité LED amovible pour la charge	Unité LED amovible pour la charge																																																																																										
Ampoule	DEL multicolores & blanc chaud 2700 K, blanc froid 6000 K, max. 7,2 W, max. 810 lm, durée de vie: 30000 h	DEL multicolores & blanc chaud 2700 K, blanc froid 6000 K, max. 7,2 W, max. 810 lm, durée de vie: 30000 h																																																																																										
Télécommande	IR	IR																																																																																										
Rechargeable battery/ ChargingTime	3.7 V, 2 x 2600 mAh (Li-Ion)/ 10 h	3.7 V, 2 x 2600 mAh (Li-Ion)/ 10 h																																																																																										
Runtime (in colour change)	11 h	11 h																																																																																										
Chargeur	100-240 V~, 50/60 Hz, Vout 5 V, 1,2 A	100-240 V~, 50/60 Hz, Vout 5 V, 1,2 A																																																																																										
Câblage	1,2 m	1,2 m																																																																																										
Tension	100-240 VAC, 50/ 60 Hz	100-240 VAC, 50/ 60 Hz																																																																																										
Catégorie	III (Produit), II (Chargeur)	III (Produit), II (Chargeur)																																																																																										
Insert pour boissons (amovible)	-	Ø 230/200 mm, H 175 mm, PP																																																																																										
Pour Utilisation Extérieure	IP54	IP54																																																																																										
Matériaux	PE satiné, résistant aux rayons UV	PE satiné, résistant aux rayons UV																																																																																										
Couleur	blanc, translucide	blanc, translucide																																																																																										
Dimensions	env. Ø 46 cm, H 89 cm	Ø 35 cm, H 70 cm																																																																																										
Poids	env. 10 kg	4,8 kg																																																																																										
Support de Lampe	Unité LED amovible pour la charge	Unité LED amovible pour la charge																																																																																										
Ampoule	DEL multicolores & blanc chaud 2700 K, blanc froid 6000 K, max. 7,2 W, max. 810 lm, durée de vie: 30000 h	DEL multicolores & blanc chaud 2700 K, blanc froid 6000 K, max. 7,2 W, max. 810 lm, durée de vie: 30000 h																																																																																										
Télécommande	IR	IR																																																																																										
Rechargeable battery/ ChargingTime	3.7 V, 2 x 2600 mAh (Li-Ion)/ 10 h	3.7 V, 2 x 2600 mAh (Li-Ion)/ 10 h																																																																																										
Runtime (in colour change)	11 h	11 h																																																																																										
Chargeur	100-240 V~, 50/60 Hz, Vout 5 V, 1,2 A	100-240 V~, 50/60 Hz, Vout 5 V, 1,2 A																																																																																										
Câblage	1,2 m	1,2 m																																																																																										
Tension	100-240 VAC, 50/ 60 Hz	100-240 VAC, 50/ 60 Hz																																																																																										
Catégorie	III (Produit), II (Chargeur)	III (Produit), II (Chargeur)																																																																																										
Insert pour boissons (amovible)	-	Ø 230/200 mm, H 175 mm, PP																																																																																										
Pour Utilisation Extérieure	IP54	IP54																																																																																										

LEUCHTEN - TECHNISCHE DATEN

LIGHTING TECHNICAL DATA | LUMIÈRES CARACTÉRISTIQUES TECHNIQUES



ARNOLD S



Ladestation
Charging Station
Station de chargement

Modell Model Modèle	ARNOLD S (WHITE) 47-01-32	ARNOLD S (ANTHRACITE) 47-02-32																																																								
	      	      																																																								
DE	<table border="1"> <tr><td>Material</td><td>Aluminium</td></tr> <tr><td>Farbe</td><td>Weiss (matt)</td></tr> <tr><td>Maße</td><td>Ø12 x H32 cm</td></tr> <tr><td>Gewicht</td><td>0,8 Kg</td></tr> <tr><td>LED-Einheit</td><td>Fest eingebaut</td></tr> <tr><td>Leuchtmittel/lm/Kelvin/Watt</td><td>LEDs (dimmbar)/180 LM (2700K), 190 LM (3000K)/ max. 2,2 W</td></tr> <tr><td>Aufladbarer Akku</td><td>DC 3.7 V, 2 x 2200 mAh (Li-Ion), austauschbar</td></tr> <tr><td>Ladezeit</td><td>Ca. 6-8 h</td></tr> <tr><td>Laufzeit</td><td>Ca. 12 h (bei 100% LED-Helligkeit), bei gedimmtem Licht länger</td></tr> <tr><td>Ladegerät</td><td>100-240 VAC, 50/60 Hz, Vout 5 V, 1 A,</td></tr> <tr><td>Kabel Ladestation</td><td>1,2 m, weiss</td></tr> <tr><td>Schutzklasse</td><td>III (Leuchte), II (Ladegerät)</td></tr> <tr><td>Für Innenbereich</td><td>Ladegerät</td></tr> <tr><td>Für Aussenbereich</td><td>IP54 (Leuchte)</td></tr> </table>	Material	Aluminium	Farbe	Weiss (matt)	Maße	Ø12 x H32 cm	Gewicht	0,8 Kg	LED-Einheit	Fest eingebaut	Leuchtmittel/lm/Kelvin/Watt	LEDs (dimmbar)/180 LM (2700K), 190 LM (3000K)/ max. 2,2 W	Aufladbarer Akku	DC 3.7 V, 2 x 2200 mAh (Li-Ion), austauschbar	Ladezeit	Ca. 6-8 h	Laufzeit	Ca. 12 h (bei 100% LED-Helligkeit), bei gedimmtem Licht länger	Ladegerät	100-240 VAC, 50/60 Hz, Vout 5 V, 1 A,	Kabel Ladestation	1,2 m, weiss	Schutzklasse	III (Leuchte), II (Ladegerät)	Für Innenbereich	Ladegerät	Für Aussenbereich	IP54 (Leuchte)	<table border="1"> <tr><td>Material</td><td>Aluminium</td></tr> <tr><td>Farbe</td><td>Anthrazit (matt)</td></tr> <tr><td>Maße</td><td>Ø12 x H32 cm</td></tr> <tr><td>Gewicht</td><td>0,8 Kg</td></tr> <tr><td>LED-Einheit</td><td>Fest eingebaut</td></tr> <tr><td>Leuchtmittel/lm/Kelvin/Watt</td><td>LEDs (dimmbar)/180 LM (2700K), 190 LM (3000K)/ max. 2,2 W</td></tr> <tr><td>Aufladbarer Akku</td><td>DC 3.7 V, 2 x 2200 mAh (Li-Ion), austauschbar</td></tr> <tr><td>Ladezeit</td><td>Ca. 6-8 h</td></tr> <tr><td>Laufzeit</td><td>Ca. 12 h (bei 100% LED-Helligkeit), bei gedimmtem Licht länger</td></tr> <tr><td>Ladegerät</td><td>100-240 VAC, 50/60 Hz, Vout 5 V, 1 A,</td></tr> <tr><td>Kabel Ladestation</td><td>1,2 m, weiss</td></tr> <tr><td>Schutzklasse</td><td>III (Leuchte), II (Ladegerät)</td></tr> <tr><td>Für Innenbereich</td><td>Ladegerät</td></tr> <tr><td>Für Aussenbereich</td><td>IP54 (Leuchte)</td></tr> </table>	Material	Aluminium	Farbe	Anthrazit (matt)	Maße	Ø12 x H32 cm	Gewicht	0,8 Kg	LED-Einheit	Fest eingebaut	Leuchtmittel/lm/Kelvin/Watt	LEDs (dimmbar)/180 LM (2700K), 190 LM (3000K)/ max. 2,2 W	Aufladbarer Akku	DC 3.7 V, 2 x 2200 mAh (Li-Ion), austauschbar	Ladezeit	Ca. 6-8 h	Laufzeit	Ca. 12 h (bei 100% LED-Helligkeit), bei gedimmtem Licht länger	Ladegerät	100-240 VAC, 50/60 Hz, Vout 5 V, 1 A,	Kabel Ladestation	1,2 m, weiss	Schutzklasse	III (Leuchte), II (Ladegerät)	Für Innenbereich	Ladegerät	Für Aussenbereich	IP54 (Leuchte)
Material	Aluminium																																																									
Farbe	Weiss (matt)																																																									
Maße	Ø12 x H32 cm																																																									
Gewicht	0,8 Kg																																																									
LED-Einheit	Fest eingebaut																																																									
Leuchtmittel/lm/Kelvin/Watt	LEDs (dimmbar)/180 LM (2700K), 190 LM (3000K)/ max. 2,2 W																																																									
Aufladbarer Akku	DC 3.7 V, 2 x 2200 mAh (Li-Ion), austauschbar																																																									
Ladezeit	Ca. 6-8 h																																																									
Laufzeit	Ca. 12 h (bei 100% LED-Helligkeit), bei gedimmtem Licht länger																																																									
Ladegerät	100-240 VAC, 50/60 Hz, Vout 5 V, 1 A,																																																									
Kabel Ladestation	1,2 m, weiss																																																									
Schutzklasse	III (Leuchte), II (Ladegerät)																																																									
Für Innenbereich	Ladegerät																																																									
Für Aussenbereich	IP54 (Leuchte)																																																									
Material	Aluminium																																																									
Farbe	Anthrazit (matt)																																																									
Maße	Ø12 x H32 cm																																																									
Gewicht	0,8 Kg																																																									
LED-Einheit	Fest eingebaut																																																									
Leuchtmittel/lm/Kelvin/Watt	LEDs (dimmbar)/180 LM (2700K), 190 LM (3000K)/ max. 2,2 W																																																									
Aufladbarer Akku	DC 3.7 V, 2 x 2200 mAh (Li-Ion), austauschbar																																																									
Ladezeit	Ca. 6-8 h																																																									
Laufzeit	Ca. 12 h (bei 100% LED-Helligkeit), bei gedimmtem Licht länger																																																									
Ladegerät	100-240 VAC, 50/60 Hz, Vout 5 V, 1 A,																																																									
Kabel Ladestation	1,2 m, weiss																																																									
Schutzklasse	III (Leuchte), II (Ladegerät)																																																									
Für Innenbereich	Ladegerät																																																									
Für Aussenbereich	IP54 (Leuchte)																																																									
EN	<table border="1"> <tr><td>Material</td><td>Aluminium</td></tr> <tr><td>Colour</td><td>Matte white</td></tr> <tr><td>Dimensions</td><td>Ø12 x H32 cm</td></tr> <tr><td>Weight</td><td>0,8 Kg</td></tr> <tr><td>LED Unit</td><td>Permanently installed</td></tr> <tr><td>llluminant</td><td>LEDs (dimmmable)/180 LM (2700K), 190 LM (3000K)/ max. 2,2 W</td></tr> <tr><td>Rechargeable battery</td><td>DC 3.7 V, 2 x 2200 mAh (Li-Ion)</td></tr> <tr><td>Charging time</td><td>6-8 h</td></tr> <tr><td>Runtime</td><td>Approx. 12 h (at 100% LED brightness), with dimmed light longer</td></tr> <tr><td>Adapter</td><td>100-240 VAC, 50/60 Hz, Vout 5 V, 1 A,</td></tr> <tr><td>Cable Charging Station</td><td>1.2 m, white</td></tr> <tr><td>Protection Class</td><td>III (Luminaire), II (Adapter)</td></tr> <tr><td>For Indoor Use</td><td>Adapter</td></tr> <tr><td>For Outdoor Use</td><td>IP54 (Luminaire)</td></tr> </table>	Material	Aluminium	Colour	Matte white	Dimensions	Ø12 x H32 cm	Weight	0,8 Kg	LED Unit	Permanently installed	llluminant	LEDs (dimmmable)/180 LM (2700K), 190 LM (3000K)/ max. 2,2 W	Rechargeable battery	DC 3.7 V, 2 x 2200 mAh (Li-Ion)	Charging time	6-8 h	Runtime	Approx. 12 h (at 100% LED brightness), with dimmed light longer	Adapter	100-240 VAC, 50/60 Hz, Vout 5 V, 1 A,	Cable Charging Station	1.2 m, white	Protection Class	III (Luminaire), II (Adapter)	For Indoor Use	Adapter	For Outdoor Use	IP54 (Luminaire)	<table border="1"> <tr><td>Material</td><td>Aluminium</td></tr> <tr><td>Colour</td><td>Matte anthracite</td></tr> <tr><td>Dimensions</td><td>Ø12 x H32 cm</td></tr> <tr><td>Weight</td><td>0,8 Kg</td></tr> <tr><td>LED Unit</td><td>Permanently installed</td></tr> <tr><td>llluminant</td><td>LEDs (dimmmable)/180 LM (2700K), 190 LM (3000K)/ max. 2,2 W</td></tr> <tr><td>Rechargeable battery</td><td>DC 3.7 V, 2 x 2200 mAh (Li-Ion)</td></tr> <tr><td>Charging time</td><td>6-8 h</td></tr> <tr><td>Runtime</td><td>Approx. 12 h (at 100% LED brightness), with dimmed light longer</td></tr> <tr><td>Adapter</td><td>100-240 VAC, 50/60 Hz, Vout 5 V, 1 A,</td></tr> <tr><td>Cable Charging Station</td><td>1.2 m, white</td></tr> <tr><td>Protection Class</td><td>III (Luminaire), II (Adapter)</td></tr> <tr><td>For Indoor Use</td><td>Adapter</td></tr> <tr><td>For Outdoor Use</td><td>IP54 (Luminaire)</td></tr> </table>	Material	Aluminium	Colour	Matte anthracite	Dimensions	Ø12 x H32 cm	Weight	0,8 Kg	LED Unit	Permanently installed	llluminant	LEDs (dimmmable)/180 LM (2700K), 190 LM (3000K)/ max. 2,2 W	Rechargeable battery	DC 3.7 V, 2 x 2200 mAh (Li-Ion)	Charging time	6-8 h	Runtime	Approx. 12 h (at 100% LED brightness), with dimmed light longer	Adapter	100-240 VAC, 50/60 Hz, Vout 5 V, 1 A,	Cable Charging Station	1.2 m, white	Protection Class	III (Luminaire), II (Adapter)	For Indoor Use	Adapter	For Outdoor Use	IP54 (Luminaire)
Material	Aluminium																																																									
Colour	Matte white																																																									
Dimensions	Ø12 x H32 cm																																																									
Weight	0,8 Kg																																																									
LED Unit	Permanently installed																																																									
llluminant	LEDs (dimmmable)/180 LM (2700K), 190 LM (3000K)/ max. 2,2 W																																																									
Rechargeable battery	DC 3.7 V, 2 x 2200 mAh (Li-Ion)																																																									
Charging time	6-8 h																																																									
Runtime	Approx. 12 h (at 100% LED brightness), with dimmed light longer																																																									
Adapter	100-240 VAC, 50/60 Hz, Vout 5 V, 1 A,																																																									
Cable Charging Station	1.2 m, white																																																									
Protection Class	III (Luminaire), II (Adapter)																																																									
For Indoor Use	Adapter																																																									
For Outdoor Use	IP54 (Luminaire)																																																									
Material	Aluminium																																																									
Colour	Matte anthracite																																																									
Dimensions	Ø12 x H32 cm																																																									
Weight	0,8 Kg																																																									
LED Unit	Permanently installed																																																									
llluminant	LEDs (dimmmable)/180 LM (2700K), 190 LM (3000K)/ max. 2,2 W																																																									
Rechargeable battery	DC 3.7 V, 2 x 2200 mAh (Li-Ion)																																																									
Charging time	6-8 h																																																									
Runtime	Approx. 12 h (at 100% LED brightness), with dimmed light longer																																																									
Adapter	100-240 VAC, 50/60 Hz, Vout 5 V, 1 A,																																																									
Cable Charging Station	1.2 m, white																																																									
Protection Class	III (Luminaire), II (Adapter)																																																									
For Indoor Use	Adapter																																																									
For Outdoor Use	IP54 (Luminaire)																																																									
FR	<table border="1"> <tr><td>Matériaux</td><td>Aluminium</td></tr> <tr><td>Couleur</td><td>Anthracite mat</td></tr> <tr><td>Dimensions</td><td>Ø12 x H32 cm</td></tr> <tr><td>Poids</td><td>0,8 Kg</td></tr> <tr><td>Unité DEL</td><td>Fixé en permanence</td></tr> <tr><td>Ampoule</td><td>LEDs (dimmmable)/ 180 LM (2700K), 190 LM (3000K)/ max. 2,2 W</td></tr> <tr><td>Batterie rechargeable</td><td>DC 3.7 V, 2 x 2200 mAh (Li-Ion)</td></tr> <tr><td>Temps de charge</td><td>6-8 h</td></tr> <tr><td>Durée</td><td>Env. 12 h (à 100% de luminosité), plus longtemps si la lumière est baissée</td></tr> <tr><td>Chargeur</td><td>100-240 VAC, 50/60 Hz, Vout 5 V, 1 A,</td></tr> <tr><td>Station de recharge</td><td>1,2 m, blanc</td></tr> <tr><td>Catégorie</td><td>III (Luminaire), II (Adaptateur)</td></tr> <tr><td>Pour Utilisation Intérieur</td><td>Chargeur</td></tr> <tr><td>Pour Utilisation Extérieure</td><td>IP54 (Luminaire)</td></tr> </table>	Matériaux	Aluminium	Couleur	Anthracite mat	Dimensions	Ø12 x H32 cm	Poids	0,8 Kg	Unité DEL	Fixé en permanence	Ampoule	LEDs (dimmmable)/ 180 LM (2700K), 190 LM (3000K)/ max. 2,2 W	Batterie rechargeable	DC 3.7 V, 2 x 2200 mAh (Li-Ion)	Temps de charge	6-8 h	Durée	Env. 12 h (à 100% de luminosité), plus longtemps si la lumière est baissée	Chargeur	100-240 VAC, 50/60 Hz, Vout 5 V, 1 A,	Station de recharge	1,2 m, blanc	Catégorie	III (Luminaire), II (Adaptateur)	Pour Utilisation Intérieur	Chargeur	Pour Utilisation Extérieure	IP54 (Luminaire)	<table border="1"> <tr><td>Matériaux</td><td>Aluminium</td></tr> <tr><td>Couleur</td><td>Anthracite mat</td></tr> <tr><td>Dimensions</td><td>Ø12 x H32 cm</td></tr> <tr><td>Poids</td><td>0,8 Kg</td></tr> <tr><td>Unité DEL</td><td>Fixé en permanence</td></tr> <tr><td>Ampoule</td><td>LEDs (dimmmable)/ 180 LM (2700K), 190 LM (3000K)/ max. 2,2 W</td></tr> <tr><td>Batterie rechargeable</td><td>DC 3.7 V, 2 x 2200 mAh (Li-Ion)</td></tr> <tr><td>Temps de charge</td><td>6-8 h</td></tr> <tr><td>Durée</td><td>Env. 12 h (à 100% de luminosité), plus longtemps si la lumière est baissée</td></tr> <tr><td>Chargeur</td><td>100-240 VAC, 50/60 Hz, Vout 5 V, 1 A,</td></tr> <tr><td>Station de recharge</td><td>1,2 m, blanc</td></tr> <tr><td>Catégorie</td><td>III (Luminaire), II (Adaptateur)</td></tr> <tr><td>Pour Utilisation Intérieur</td><td>Chargeur</td></tr> <tr><td>Pour Utilisation Extérieure</td><td>IP54 (Luminaire)</td></tr> </table>	Matériaux	Aluminium	Couleur	Anthracite mat	Dimensions	Ø12 x H32 cm	Poids	0,8 Kg	Unité DEL	Fixé en permanence	Ampoule	LEDs (dimmmable)/ 180 LM (2700K), 190 LM (3000K)/ max. 2,2 W	Batterie rechargeable	DC 3.7 V, 2 x 2200 mAh (Li-Ion)	Temps de charge	6-8 h	Durée	Env. 12 h (à 100% de luminosité), plus longtemps si la lumière est baissée	Chargeur	100-240 VAC, 50/60 Hz, Vout 5 V, 1 A,	Station de recharge	1,2 m, blanc	Catégorie	III (Luminaire), II (Adaptateur)	Pour Utilisation Intérieur	Chargeur	Pour Utilisation Extérieure	IP54 (Luminaire)
Matériaux	Aluminium																																																									
Couleur	Anthracite mat																																																									
Dimensions	Ø12 x H32 cm																																																									
Poids	0,8 Kg																																																									
Unité DEL	Fixé en permanence																																																									
Ampoule	LEDs (dimmmable)/ 180 LM (2700K), 190 LM (3000K)/ max. 2,2 W																																																									
Batterie rechargeable	DC 3.7 V, 2 x 2200 mAh (Li-Ion)																																																									
Temps de charge	6-8 h																																																									
Durée	Env. 12 h (à 100% de luminosité), plus longtemps si la lumière est baissée																																																									
Chargeur	100-240 VAC, 50/60 Hz, Vout 5 V, 1 A,																																																									
Station de recharge	1,2 m, blanc																																																									
Catégorie	III (Luminaire), II (Adaptateur)																																																									
Pour Utilisation Intérieur	Chargeur																																																									
Pour Utilisation Extérieure	IP54 (Luminaire)																																																									
Matériaux	Aluminium																																																									
Couleur	Anthracite mat																																																									
Dimensions	Ø12 x H32 cm																																																									
Poids	0,8 Kg																																																									
Unité DEL	Fixé en permanence																																																									
Ampoule	LEDs (dimmmable)/ 180 LM (2700K), 190 LM (3000K)/ max. 2,2 W																																																									
Batterie rechargeable	DC 3.7 V, 2 x 2200 mAh (Li-Ion)																																																									
Temps de charge	6-8 h																																																									
Durée	Env. 12 h (à 100% de luminosité), plus longtemps si la lumière est baissée																																																									
Chargeur	100-240 VAC, 50/60 Hz, Vout 5 V, 1 A,																																																									
Station de recharge	1,2 m, blanc																																																									
Catégorie	III (Luminaire), II (Adaptateur)																																																									
Pour Utilisation Intérieur	Chargeur																																																									
Pour Utilisation Extérieure	IP54 (Luminaire)																																																									

EMILY



Ladestation
Charging Station
Station de chargement

Modell Model Modèle	EMILY M 46-01-38	EMILY L 46-01-54	
	     	     	
DE	Material	Aluminium	Aluminium
	Farbe	Anthrazit (matt)	Anthrazit (matt)
	Maße	B14 x T14 x H38 cm	B14 x T14 x H54 cm
	Gewicht	1,5 Kg	1,5 Kg
	LED-Einheit	Fest eingebaut	Fest eingebaut
	Leuchtmittel/lm/Kelvin/Watt	LEDs (dimmbar)/ 180 lm/ 3000K, warmweiß/ max. 2,2 W	LEDs (dimmbar)/ 180 lm/ 3000K, warmweiß/ max. 2,2 W
	Aufladbarer Akku	DC 3.7 V, 2 x 2200 mAh (Li-Ion), austauschbar	DC 3.7 V, 2 x 2200 mAh (Li-Ion), austauschbar
	Ladezeit	Ca. 8 h	Ca. 8 h
	Laufzeit	Ca. 11 h (bei 100% LED-Helligkeit), bei gedimmtem Licht länger	Ca. 11 h (bei 100% LED-Helligkeit), bei gedimmtem Licht länger
	Ladegerät	Vout 5 V / 1 A	Vout 5 V / 1 A
	Kabel Ladestation	1,2 m, weiss	1,2 m, weiss
	Schutzklasse	III (Leuchte), II (Ladegerät)	III (Leuchte), II (Ladegerät)
	Für Innenbereich	Ladegerät	Ladegerät
	Für Aussenbereich	IP54 (Leuchte)	IP54 (Leuchte)
EN	Material	Aluminium	Aluminium
	Colour	Matte anthracite	Matte anthracite
	Dimensions	W14 x D14 x H38 cm	W14 x D14 x H54 cm
	Weight	1.5 Kg	1.5 Kg
	LED Unit	Permanently installed	Permanently installed
	Illuminant	LEDs (dimmbable)/ 180 lm/ 3000K, warmwhite/ max. 2.2 W	LEDs (dimmbable)/ 180 lm/ 3000K, warmwhite/ max. 2.2 W
	Rechargeable battery	DC 3.7 V, 2 x 2200 mAh (Li-Ion)	DC 3.7 V, 2 x 2200 mAh (Li-Ion)
	Charging time	8 h	8 h
	Runtime	Approx. 11 h (at 100% LED brightness), with dimmed light longer	Approx. 11 h (at 100% LED brightness), with dimmed light longer
	Adapter	Vout 5 V / 1 A	Vout 5 V / 1 A
	Cable Charging Station	1.2 m, white	1.2 m, white
	Protection Class	III (Lamp), II (Adapter)	III (Lamp), II (Adapter)
	For Indoor Use	Adapter	Adapter
	For Outdoor Use	IP54 (Lamp)	IP54 (Lamp)
FR	Matériaux	Aluminium	Aluminium
	Couleur	Anthracite mat	Anthracite mat
	Dimensions	L14 x L14 x H38 cm	L14 x L14 x H54 cm
	Poids	1.5 kg	1.5 kg
	Unité DEL	Fixé en permanence	Fixé en permanence
	Ampoule	LEDs (dimmbable)/ 180 lm/ 3000K, blanc chaud / max. 2,2 W	LEDs (dimmbable)/ 180 lm/ 3000K, blanc chaud / max. 2,2 W
	Batterie rechargeable	DC 3.7 V, 2 x 2200 mAh (Li-Ion)	DC 3.7 V, 2 x 2200 mAh (Li-Ion)
	Temps de charge	8 h	8 h
	Durée	Env. 11 h (à 100% de luminosité), plus longtemps si la lumière est baissée	Env. 11 h (à 100% de luminosité), plus longtemps si la lumière est baissée
	Chargeur	Vout 5 V / 1 A	Vout 5 V / 1 A
	Station de recharge	1,2 m, blanc	1,2 m, blanc
	Catégorie	III (Lampe), II (Adaptateur)	III (Lampe), II (Adaptateur)
	Pour Utilisation Intérieur	Chargeur	Chargeur
	Pour Utilisation Extérieure	IP54 (Lampe)	IP54 (Lampe)



Modell | Model | Modèle

LOUIS (WHITE)

38-01-36



LOUIS (ANTHRACITE)

38-02-36



DE	Material	Aluminium	Aluminium
	Farbe	Mattweiß	Anthrazit (matt)
	Maße	B17,5 x T17,5 x H36 cm (mit Griff vertikal H 49 cm) (mit Griff horizontal B 22,3 cm)	B17,5 x T17,5 x H36 cm (mit Griff vertikal H 49 cm) (mit Griff horizontal B 22,3 cm)
	Gewicht	ca. 1,6 kg	ca. 1,6 kg
	Lampenfassung	EINGEBAUTE LED-Einheit (ausbaubar)	EINGEBAUTE LED-Einheit (ausbaubar)
	Leuchtmittel/ lm/ Kelvin/ Watt	LEDs (dimmbar)/ 238 lm/ 3000K, warmweiß/ max. 3 W	LEDs (dimmbar)/ 238 lm/ 3000K, warmweiß/ max. 3 W
	Aufladbarer Akku	DC 3.7 V, 2 x 2200 mAh (Li-Ion)	DC 3.7 V, 2 x 2200 mAh (Li-Ion)
	Ladezeit mit Ladegerät/ Sonnenschein Laufzeit	Ladegerät 5-7/ Sonne ca.16-17 Std. Ca. 9 Std. (100% Helligkeit)	Ladegerät 5-7/ Sonne ca.16-17 Std. Ca. 9 Std. (100% Helligkeit)
	Ladegerät	Vout 5 V / 1 A	Vout 5 V / 1 A
	Verkabelung	1,8 m, weiss	1,8 m, weiss
	Schutzklasse	III (Laterne), II (Ladegerät)	III (Laterne), II (Ladegerät)
	Für Innenbereich	Ladegerät	Ladegerät
	Für Aussenbereich	IP54 (Laterne)	IP54 (Laterne)
EN	Material	Aluminium	Aluminium
	Colour	Matte white	Matte anthracite
	Dimensions	W17,5 x D17,5 x H36 cm (with vertical handle H49 cm) (with horizontal handle W22.3 cm)	W17,5 x D17,5 x H36 cm (with vertical handle H49 cm) (with horizontal handle W22.3 cm)
	Weight	1.6 kg	1.6 kg
	Lamp Holder	Built-In LED Unit (removable)	Built-In LED Unit (removable)
	Illuminant	LEDs (dimmbable)/ 238 lm/ 3000K, warmwhite/ max. 3 W	LEDs (dimmbable)/ 238 lm/ 3000K, warmwhite/ max. 3 W
	Rechargeable battery	DC 3.7 V, 2 x 2200 mAh (Li-Ion)	DC 3.7 V, 2 x 2200 mAh (Li-Ion)
	Charging time adapter/ Solar Runtime	USB 5-7 h, Sunshine 16-17 h 12 h approx. 9 h (100% brightness)	USB 5-7 h, Sunshine 16-17 h 12 h approx. 9 h (100% brightness)
	Adapter	Vout 5 V / 1 A	Vout 5 V / 1 A
	Cable	1.8 m, white	1.8 m, white
	Protection Class	III (Product), II (Charger)	III (Product), II (Charger)
	For Indoor Use	Adapter	Adapter
	For Outdoor Use	IP54 (Lantern)	IP54 (Lantern)
FR	Matériaux	Aluminium	Aluminium
	Couleur	Blanc mat	Anthracite mat
	Dimensions	L17,5 x P17,5 x H36 cm (avec poignée verticale H 49 cm) (avec poignée horizontale L 22,3 cm)	L17,5 x P17,5 x H36 cm (avec poignée verticale H 49 cm) (avec poignée horizontale L 22,3 cm)
	Poids	env. 1,6 kg	env. 1,6 kg
	Support de Lampe	Unité à LED intégrée (amovible)	Unité à LED intégrée (amovible)
	Ampoule	LEDs (dimmbable)/ 238 lm/ 3000K, blanc chaud / max. 3 W	LEDs (dimmbable)/ 238 lm/ 3000K, blanc chaud / max. 3 W
	Batterie rechargeable	DC 3.7 V, 2 x 2200 mAh (Li-Ion)	DC 3.7 V, 2 x 2200 mAh (Li-Ion)
	Temps de charge avec chargeur/ soleil Durée	Chargeur 5-7 / soleil env. 16-17 heures Env. 9 heures (luminosité 100%)	Chargeur 5-7 / soleil env. 16-17 heures Env. 9 heures (luminosité 100%)
	Chargeur	Vout 5 V / 1 A	Vout 5 V / 1 A
	Câblage	1,8 m, blanc	1,8 m, blanc
	Catégorie	III (lanterne), II (chargeur)	III (lanterne), II (chargeur)
	Pour Utilisation Intérieur	Chargeur	Chargeur
	Pour Utilisation Extérieure	IP54 (Lanterne)	IP54 (Lanterne)

SPOT.E



160

SPOT.E

43-01-01

Modell | Model | Modèle



DE	Material	Aluminium
	Farbe	Anthrazit
	Maße	B225 x T140 x H115 mm
	Gewicht	1 kg
	LED-Einheit	Fest verbaut
	Leuchtmittel/ lm/ Kelvin/Watt	LEDs / 110 lm/ 3000K, warmweiß/ max. 1,3 W
	Aufladbarer Akku	DC 3.7 V, 1 x 2200 mAh (Li-Ion)
	Ladezeit bei Sonnenschein	Ca. 8 Std
	Laufzeit	Ca. 7 Std
	Solarpanel	2 W
	Ein/Aus Schalter	Beleuchtet
	Helligkeitssensor	Automatisches Ein-/Ausschalten durch Helligkeitssensor bei 20-30 Lux
	Schutzklasse	III
	Für Aussenbereich	IP65

EN	Material	Aluminium
	Colour	Matte anthracite
	Dimensions	W225 x D140 x H115 mm
	Weight	1 Kg
	LED Unit	Permanently installed
	Illuminant	LEDs / 110lm/ 3000K, warmwhite/ max. 1.3 W
	Rechargeable battery	DC 3.7 V, 1 x 2200 mAh (Li-Ion)
	Charging Time Solar	Approx 8 h
	Runtime	Approx. 7 h
	Solar Panel	2 W
	ON/OFF Switch	Illuminated
	Brightness Sensor	Automatic ON/OFF at 20-30 lux
	Protection Class	III (Lamp)
	For Outdoor Use	IP65 (Lamp)

FR	Matériaux	Aluminium
	Couleur	Anthracite
	Dimensions	L225 x P140 x H115 mm
	Poids	1 kg
	Unité à LED	Fixé en permanence
	Ampoule	LEDs (dimmable)/ 110 lm/ 3000K, blanc chaud / max. 1,3 W
	Batterie rechargeable	DC 3.7 V, 1 x 2200 mAh (Li-Ion)
	Temps de charge soleil	Env. 8 heures
	Durée	Env. 7 heures
	Panneau Solaire	2 W
	Interrupteur marche/arrêt	éclairé
	Mise en marche/arrêt	automatique par capteur de luminosité à 20-30 lux
	Catégorie	III (Lanterne)
	Pour Utilisation Extérieure	IP65 (Lanterne)

ARNOLD XL

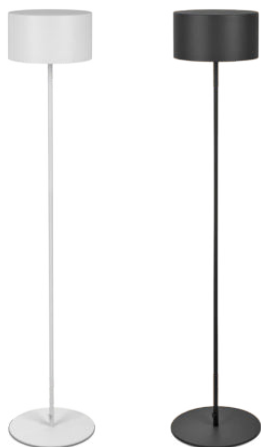

Modell Model Modèle	ARNOLD XL (WHITE) 47-01-138	ARNOLD XL (ANTHRACITE) 47-02-138																																																																														
DE	<table border="1"> <tr><td>Material</td><td>Aluminium</td><td>Aluminium</td></tr> <tr><td>Farbe</td><td>Mattweiß</td><td>Anthrazit (matt)</td></tr> <tr><td>Maße der 3 einstellbaren Höhen</td><td>Ø29 x H138 cm</td><td>Ø29 x H138 cm</td></tr> <tr><td>Gewicht</td><td>6,4 Kg</td><td>6,4 Kg</td></tr> <tr><td>Lampenfassung</td><td>EINGEBAUTE LED-Einheit (ausbaubar)</td><td>EINGEBAUTE LED-Einheit (ausbaubar)</td></tr> <tr><td>Leuchtmittel/ lm/ Kelvin/ Watt</td><td>LEDs (dimmbar)/ 468 lm/ 3000K, warmweiß/ max. 4,5 W</td><td>LEDs (dimmbar)/ 468 lm/ 3000K, warmweiß/ max. 4,5 W</td></tr> <tr><td>Aufladbarer Akku</td><td>DC 3.7 V, 3 x 2200 mAh (Li-Ion)</td><td>DC 3.7 V, 3 x 2200 mAh (Li-Ion)</td></tr> <tr><td>Ladezeit mit Ladegerät</td><td>5-7 Std.</td><td>5-7 Std.</td></tr> <tr><td>Laufzeit</td><td>Ca. 9 Std. (bei 100% Helligkeit)</td><td>Ca. 9 Std. (bei 100% Helligkeit)</td></tr> <tr><td>Ladegerät</td><td>100-240 VAC, 50/60 Hz, Vout 5 V, 1 A</td><td>100-240 VAC, 50/60 Hz, Vout 5 V, 1 A</td></tr> <tr><td>Schutzklasse</td><td>III (Stehleuchte), II (Ladegerät)</td><td>III (Stehleuchte), II (Ladegerät)</td></tr> <tr><td>Für Innenbereich</td><td>Ladegerät</td><td>Ladegerät</td></tr> <tr><td>Für Aussenbereich</td><td>IP54 (Stehleuchte)</td><td>IP54 (Stehleuchte)</td></tr> </table>	Material	Aluminium	Aluminium	Farbe	Mattweiß	Anthrazit (matt)	Maße der 3 einstellbaren Höhen	Ø29 x H138 cm	Ø29 x H138 cm	Gewicht	6,4 Kg	6,4 Kg	Lampenfassung	EINGEBAUTE LED-Einheit (ausbaubar)	EINGEBAUTE LED-Einheit (ausbaubar)	Leuchtmittel/ lm/ Kelvin/ Watt	LEDs (dimmbar)/ 468 lm/ 3000K, warmweiß/ max. 4,5 W	LEDs (dimmbar)/ 468 lm/ 3000K, warmweiß/ max. 4,5 W	Aufladbarer Akku	DC 3.7 V, 3 x 2200 mAh (Li-Ion)	DC 3.7 V, 3 x 2200 mAh (Li-Ion)	Ladezeit mit Ladegerät	5-7 Std.	5-7 Std.	Laufzeit	Ca. 9 Std. (bei 100% Helligkeit)	Ca. 9 Std. (bei 100% Helligkeit)	Ladegerät	100-240 VAC, 50/60 Hz, Vout 5 V, 1 A	100-240 VAC, 50/60 Hz, Vout 5 V, 1 A	Schutzklasse	III (Stehleuchte), II (Ladegerät)	III (Stehleuchte), II (Ladegerät)	Für Innenbereich	Ladegerät	Ladegerät	Für Aussenbereich	IP54 (Stehleuchte)	IP54 (Stehleuchte)	<table border="1"> <tr><td>Material</td><td>Aluminium</td><td>Aluminium</td></tr> <tr><td>Farbe</td><td>Mattweiß</td><td>Anthrazit (matt)</td></tr> <tr><td>Maße der 3 einstellbaren Höhen</td><td>Ø29 x H138 cm</td><td>Ø29 x H138 cm</td></tr> <tr><td>Gewicht</td><td>6,4 Kg</td><td>6,4 Kg</td></tr> <tr><td>Lampenfassung</td><td>EINGEBAUTE LED-Einheit (ausbaubar)</td><td>EINGEBAUTE LED-Einheit (ausbaubar)</td></tr> <tr><td>Leuchtmittel/ lm/ Kelvin/ Watt</td><td>LEDs (dimmbar)/ 468 lm/ 3000K, warmweiß/ max. 4,5 W</td><td>LEDs (dimmbar)/ 468 lm/ 3000K, warmweiß/ max. 4,5 W</td></tr> <tr><td>Aufladbarer Akku</td><td>DC 3.7 V, 3 x 2200 mAh (Li-Ion)</td><td>DC 3.7 V, 3 x 2200 mAh (Li-Ion)</td></tr> <tr><td>Ladezeit mit Ladegerät</td><td>5-7 Std.</td><td>5-7 Std.</td></tr> <tr><td>Laufzeit</td><td>Ca. 9 Std. (bei 100% Helligkeit)</td><td>Ca. 9 Std. (bei 100% Helligkeit)</td></tr> <tr><td>Ladegerät</td><td>100-240 VAC, 50/60 Hz, Vout 5 V, 1 A</td><td>100-240 VAC, 50/60 Hz, Vout 5 V, 1 A</td></tr> <tr><td>Schutzklasse</td><td>III (Stehleuchte), II (Ladegerät)</td><td>III (Stehleuchte), II (Ladegerät)</td></tr> <tr><td>Für Innenbereich</td><td>Ladegerät</td><td>Ladegerät</td></tr> <tr><td>Für Aussenbereich</td><td>IP54 (Stehleuchte)</td><td>IP54 (Stehleuchte)</td></tr> </table>	Material	Aluminium	Aluminium	Farbe	Mattweiß	Anthrazit (matt)	Maße der 3 einstellbaren Höhen	Ø29 x H138 cm	Ø29 x H138 cm	Gewicht	6,4 Kg	6,4 Kg	Lampenfassung	EINGEBAUTE LED-Einheit (ausbaubar)	EINGEBAUTE LED-Einheit (ausbaubar)	Leuchtmittel/ lm/ Kelvin/ Watt	LEDs (dimmbar)/ 468 lm/ 3000K, warmweiß/ max. 4,5 W	LEDs (dimmbar)/ 468 lm/ 3000K, warmweiß/ max. 4,5 W	Aufladbarer Akku	DC 3.7 V, 3 x 2200 mAh (Li-Ion)	DC 3.7 V, 3 x 2200 mAh (Li-Ion)	Ladezeit mit Ladegerät	5-7 Std.	5-7 Std.	Laufzeit	Ca. 9 Std. (bei 100% Helligkeit)	Ca. 9 Std. (bei 100% Helligkeit)	Ladegerät	100-240 VAC, 50/60 Hz, Vout 5 V, 1 A	100-240 VAC, 50/60 Hz, Vout 5 V, 1 A	Schutzklasse	III (Stehleuchte), II (Ladegerät)	III (Stehleuchte), II (Ladegerät)	Für Innenbereich	Ladegerät	Ladegerät	Für Aussenbereich	IP54 (Stehleuchte)	IP54 (Stehleuchte)
Material	Aluminium	Aluminium																																																																														
Farbe	Mattweiß	Anthrazit (matt)																																																																														
Maße der 3 einstellbaren Höhen	Ø29 x H138 cm	Ø29 x H138 cm																																																																														
Gewicht	6,4 Kg	6,4 Kg																																																																														
Lampenfassung	EINGEBAUTE LED-Einheit (ausbaubar)	EINGEBAUTE LED-Einheit (ausbaubar)																																																																														
Leuchtmittel/ lm/ Kelvin/ Watt	LEDs (dimmbar)/ 468 lm/ 3000K, warmweiß/ max. 4,5 W	LEDs (dimmbar)/ 468 lm/ 3000K, warmweiß/ max. 4,5 W																																																																														
Aufladbarer Akku	DC 3.7 V, 3 x 2200 mAh (Li-Ion)	DC 3.7 V, 3 x 2200 mAh (Li-Ion)																																																																														
Ladezeit mit Ladegerät	5-7 Std.	5-7 Std.																																																																														
Laufzeit	Ca. 9 Std. (bei 100% Helligkeit)	Ca. 9 Std. (bei 100% Helligkeit)																																																																														
Ladegerät	100-240 VAC, 50/60 Hz, Vout 5 V, 1 A	100-240 VAC, 50/60 Hz, Vout 5 V, 1 A																																																																														
Schutzklasse	III (Stehleuchte), II (Ladegerät)	III (Stehleuchte), II (Ladegerät)																																																																														
Für Innenbereich	Ladegerät	Ladegerät																																																																														
Für Aussenbereich	IP54 (Stehleuchte)	IP54 (Stehleuchte)																																																																														
Material	Aluminium	Aluminium																																																																														
Farbe	Mattweiß	Anthrazit (matt)																																																																														
Maße der 3 einstellbaren Höhen	Ø29 x H138 cm	Ø29 x H138 cm																																																																														
Gewicht	6,4 Kg	6,4 Kg																																																																														
Lampenfassung	EINGEBAUTE LED-Einheit (ausbaubar)	EINGEBAUTE LED-Einheit (ausbaubar)																																																																														
Leuchtmittel/ lm/ Kelvin/ Watt	LEDs (dimmbar)/ 468 lm/ 3000K, warmweiß/ max. 4,5 W	LEDs (dimmbar)/ 468 lm/ 3000K, warmweiß/ max. 4,5 W																																																																														
Aufladbarer Akku	DC 3.7 V, 3 x 2200 mAh (Li-Ion)	DC 3.7 V, 3 x 2200 mAh (Li-Ion)																																																																														
Ladezeit mit Ladegerät	5-7 Std.	5-7 Std.																																																																														
Laufzeit	Ca. 9 Std. (bei 100% Helligkeit)	Ca. 9 Std. (bei 100% Helligkeit)																																																																														
Ladegerät	100-240 VAC, 50/60 Hz, Vout 5 V, 1 A	100-240 VAC, 50/60 Hz, Vout 5 V, 1 A																																																																														
Schutzklasse	III (Stehleuchte), II (Ladegerät)	III (Stehleuchte), II (Ladegerät)																																																																														
Für Innenbereich	Ladegerät	Ladegerät																																																																														
Für Aussenbereich	IP54 (Stehleuchte)	IP54 (Stehleuchte)																																																																														
EN	<table border="1"> <tr><td>Material</td><td>Aluminium</td><td>Aluminium</td></tr> <tr><td>Colour</td><td>Matte white</td><td>Matte anthracite</td></tr> <tr><td>Dimensions</td><td>Ø29 x H138 cm</td><td>Ø29 x H138 cm</td></tr> <tr><td>Weight</td><td>6,4 Kg</td><td>6,4 Kg</td></tr> <tr><td>Lamp Holder</td><td>Built-In LED Unit (removable)</td><td>Built-In LED Unit (removable)</td></tr> <tr><td>Illuminant</td><td>LEDs (dimmbable)/ 468 lm/ 3000K, warmwhite/ max. 4.5 W</td><td>LEDs (dimmbable)/ 468 lm/ 3000K, warmwhite/ max. 4.5 W</td></tr> <tr><td>Rechargeable battery</td><td>DC 3.7 V, 3 x 2200 mAh (Li-Ion)</td><td>DC 3.7 V, 3 x 2200 mAh (Li-Ion)</td></tr> <tr><td>Charging time adapter</td><td>5-7 h</td><td>5-7 h</td></tr> <tr><td>Runtime</td><td>approx. 9 h (100% brightness)</td><td>approx. 9 h (100% brightness)</td></tr> <tr><td>Adapter</td><td>100-240 VAC, 50/60 Hz, Vout 5 V, 1 A</td><td>100-240 VAC, 50/60 Hz, Vout 5 V, 1 A</td></tr> <tr><td>Protection Class</td><td>III (Floor Lamp), II (Adapter)</td><td>III (Floor Lamp), II (Adapter)</td></tr> <tr><td>For Indoor Use</td><td>Adapter</td><td>Adapter</td></tr> <tr><td>For Outdoor Use</td><td>IP54 (Floor Lamp)</td><td>IP54 (Floor Lamp)</td></tr> </table>	Material	Aluminium	Aluminium	Colour	Matte white	Matte anthracite	Dimensions	Ø29 x H138 cm	Ø29 x H138 cm	Weight	6,4 Kg	6,4 Kg	Lamp Holder	Built-In LED Unit (removable)	Built-In LED Unit (removable)	Illuminant	LEDs (dimmbable)/ 468 lm/ 3000K, warmwhite/ max. 4.5 W	LEDs (dimmbable)/ 468 lm/ 3000K, warmwhite/ max. 4.5 W	Rechargeable battery	DC 3.7 V, 3 x 2200 mAh (Li-Ion)	DC 3.7 V, 3 x 2200 mAh (Li-Ion)	Charging time adapter	5-7 h	5-7 h	Runtime	approx. 9 h (100% brightness)	approx. 9 h (100% brightness)	Adapter	100-240 VAC, 50/60 Hz, Vout 5 V, 1 A	100-240 VAC, 50/60 Hz, Vout 5 V, 1 A	Protection Class	III (Floor Lamp), II (Adapter)	III (Floor Lamp), II (Adapter)	For Indoor Use	Adapter	Adapter	For Outdoor Use	IP54 (Floor Lamp)	IP54 (Floor Lamp)	<table border="1"> <tr><td>Material</td><td>Aluminium</td><td>Aluminium</td></tr> <tr><td>Colour</td><td>Matte white</td><td>Matte anthracite</td></tr> <tr><td>Dimensions</td><td>Ø29 x H138 cm</td><td>Ø29 x H138 cm</td></tr> <tr><td>Weight</td><td>6,4 Kg</td><td>6,4 Kg</td></tr> <tr><td>Lamp Holder</td><td>Built-In LED Unit (removable)</td><td>Built-In LED Unit (removable)</td></tr> <tr><td>Illuminant</td><td>LEDs (dimmbable)/ 468 lm/ 3000K, warmwhite/ max. 4.5 W</td><td>LEDs (dimmbable)/ 468 lm/ 3000K, warmwhite/ max. 4.5 W</td></tr> <tr><td>Rechargeable battery</td><td>DC 3.7 V, 3 x 2200 mAh (Li-Ion)</td><td>DC 3.7 V, 3 x 2200 mAh (Li-Ion)</td></tr> <tr><td>Charging time adapter</td><td>5-7 h</td><td>5-7 h</td></tr> <tr><td>Runtime</td><td>approx. 9 h (100% brightness)</td><td>approx. 9 h (100% brightness)</td></tr> <tr><td>Adapter</td><td>100-240 VAC, 50/60 Hz, Vout 5 V, 1 A</td><td>100-240 VAC, 50/60 Hz, Vout 5 V, 1 A</td></tr> <tr><td>Protection Class</td><td>III (Floor Lamp), II (Adapter)</td><td>III (Floor Lamp), II (Adapter)</td></tr> <tr><td>For Indoor Use</td><td>Adapter</td><td>Adapter</td></tr> <tr><td>For Outdoor Use</td><td>IP54 (Floor Lamp)</td><td>IP54 (Floor Lamp)</td></tr> </table>	Material	Aluminium	Aluminium	Colour	Matte white	Matte anthracite	Dimensions	Ø29 x H138 cm	Ø29 x H138 cm	Weight	6,4 Kg	6,4 Kg	Lamp Holder	Built-In LED Unit (removable)	Built-In LED Unit (removable)	Illuminant	LEDs (dimmbable)/ 468 lm/ 3000K, warmwhite/ max. 4.5 W	LEDs (dimmbable)/ 468 lm/ 3000K, warmwhite/ max. 4.5 W	Rechargeable battery	DC 3.7 V, 3 x 2200 mAh (Li-Ion)	DC 3.7 V, 3 x 2200 mAh (Li-Ion)	Charging time adapter	5-7 h	5-7 h	Runtime	approx. 9 h (100% brightness)	approx. 9 h (100% brightness)	Adapter	100-240 VAC, 50/60 Hz, Vout 5 V, 1 A	100-240 VAC, 50/60 Hz, Vout 5 V, 1 A	Protection Class	III (Floor Lamp), II (Adapter)	III (Floor Lamp), II (Adapter)	For Indoor Use	Adapter	Adapter	For Outdoor Use	IP54 (Floor Lamp)	IP54 (Floor Lamp)
Material	Aluminium	Aluminium																																																																														
Colour	Matte white	Matte anthracite																																																																														
Dimensions	Ø29 x H138 cm	Ø29 x H138 cm																																																																														
Weight	6,4 Kg	6,4 Kg																																																																														
Lamp Holder	Built-In LED Unit (removable)	Built-In LED Unit (removable)																																																																														
Illuminant	LEDs (dimmbable)/ 468 lm/ 3000K, warmwhite/ max. 4.5 W	LEDs (dimmbable)/ 468 lm/ 3000K, warmwhite/ max. 4.5 W																																																																														
Rechargeable battery	DC 3.7 V, 3 x 2200 mAh (Li-Ion)	DC 3.7 V, 3 x 2200 mAh (Li-Ion)																																																																														
Charging time adapter	5-7 h	5-7 h																																																																														
Runtime	approx. 9 h (100% brightness)	approx. 9 h (100% brightness)																																																																														
Adapter	100-240 VAC, 50/60 Hz, Vout 5 V, 1 A	100-240 VAC, 50/60 Hz, Vout 5 V, 1 A																																																																														
Protection Class	III (Floor Lamp), II (Adapter)	III (Floor Lamp), II (Adapter)																																																																														
For Indoor Use	Adapter	Adapter																																																																														
For Outdoor Use	IP54 (Floor Lamp)	IP54 (Floor Lamp)																																																																														
Material	Aluminium	Aluminium																																																																														
Colour	Matte white	Matte anthracite																																																																														
Dimensions	Ø29 x H138 cm	Ø29 x H138 cm																																																																														
Weight	6,4 Kg	6,4 Kg																																																																														
Lamp Holder	Built-In LED Unit (removable)	Built-In LED Unit (removable)																																																																														
Illuminant	LEDs (dimmbable)/ 468 lm/ 3000K, warmwhite/ max. 4.5 W	LEDs (dimmbable)/ 468 lm/ 3000K, warmwhite/ max. 4.5 W																																																																														
Rechargeable battery	DC 3.7 V, 3 x 2200 mAh (Li-Ion)	DC 3.7 V, 3 x 2200 mAh (Li-Ion)																																																																														
Charging time adapter	5-7 h	5-7 h																																																																														
Runtime	approx. 9 h (100% brightness)	approx. 9 h (100% brightness)																																																																														
Adapter	100-240 VAC, 50/60 Hz, Vout 5 V, 1 A	100-240 VAC, 50/60 Hz, Vout 5 V, 1 A																																																																														
Protection Class	III (Floor Lamp), II (Adapter)	III (Floor Lamp), II (Adapter)																																																																														
For Indoor Use	Adapter	Adapter																																																																														
For Outdoor Use	IP54 (Floor Lamp)	IP54 (Floor Lamp)																																																																														
FR	<table border="1"> <tr><td>Matériaux</td><td>Aluminium</td><td>Aluminium</td></tr> <tr><td>Couleur</td><td>Blanc mat</td><td>Anthracite mat</td></tr> <tr><td>Dimensions</td><td>Ø29 x H138 cm</td><td>Ø29 x H138 cm</td></tr> <tr><td>Poids</td><td>6,4 Kg</td><td>6,4 Kg</td></tr> <tr><td>Support de Lampe</td><td>Unité à LED intégrée (amovible)</td><td>Unité à LED intégrée (amovible)</td></tr> <tr><td>Ampoule</td><td>LEDs (dimmbable)/ 468 lm/ 3000K, blanc chaud / max. 4,5 W</td><td>LEDs (dimmbable)/ 468 lm/ 3000K, blanc chaud / max. 4,5 W</td></tr> <tr><td>Batterie rechargeable</td><td>DC 3.7 V, 3 x 2200 mAh (Li-Ion)</td><td>DC 3.7 V, 3 x 2200 mAh (Li-Ion)</td></tr> <tr><td>Temps de charge avec chargeur</td><td>5-7 h</td><td>5-7 h</td></tr> <tr><td>Durée</td><td>Env. 9 heures (luminosité 100%)</td><td>Env. 9 heures (luminosité 100%)</td></tr> <tr><td>Chargeur</td><td>100-240 VAC, 50/60 Hz, Vout 5 V, 1 A</td><td>100-240 VAC, 50/60 Hz, Vout 5 V, 1 A</td></tr> <tr><td>Catégorie</td><td>III (Luminaire), II (Adaptateur)</td><td>III (Luminaire), II (Adaptateur)</td></tr> <tr><td>Pour Utilisation Intérieure</td><td>Chargeur</td><td>Chargeur</td></tr> <tr><td>Pour Utilisation Extérieure</td><td>IP54 (Luminaire)</td><td>IP54 (Luminaire)</td></tr> </table>	Matériaux	Aluminium	Aluminium	Couleur	Blanc mat	Anthracite mat	Dimensions	Ø29 x H138 cm	Ø29 x H138 cm	Poids	6,4 Kg	6,4 Kg	Support de Lampe	Unité à LED intégrée (amovible)	Unité à LED intégrée (amovible)	Ampoule	LEDs (dimmbable)/ 468 lm/ 3000K, blanc chaud / max. 4,5 W	LEDs (dimmbable)/ 468 lm/ 3000K, blanc chaud / max. 4,5 W	Batterie rechargeable	DC 3.7 V, 3 x 2200 mAh (Li-Ion)	DC 3.7 V, 3 x 2200 mAh (Li-Ion)	Temps de charge avec chargeur	5-7 h	5-7 h	Durée	Env. 9 heures (luminosité 100%)	Env. 9 heures (luminosité 100%)	Chargeur	100-240 VAC, 50/60 Hz, Vout 5 V, 1 A	100-240 VAC, 50/60 Hz, Vout 5 V, 1 A	Catégorie	III (Luminaire), II (Adaptateur)	III (Luminaire), II (Adaptateur)	Pour Utilisation Intérieure	Chargeur	Chargeur	Pour Utilisation Extérieure	IP54 (Luminaire)	IP54 (Luminaire)	<table border="1"> <tr><td>Matériaux</td><td>Aluminium</td><td>Aluminium</td></tr> <tr><td>Couleur</td><td>Blanc mat</td><td>Anthracite mat</td></tr> <tr><td>Dimensions</td><td>Ø29 x H138 cm</td><td>Ø29 x H138 cm</td></tr> <tr><td>Poids</td><td>6,4 Kg</td><td>6,4 Kg</td></tr> <tr><td>Support de Lampe</td><td>Unité à LED intégrée (amovible)</td><td>Unité à LED intégrée (amovible)</td></tr> <tr><td>Ampoule</td><td>LEDs (dimmbable)/ 468 lm/ 3000K, blanc chaud / max. 4,5 W</td><td>LEDs (dimmbable)/ 468 lm/ 3000K, blanc chaud / max. 4,5 W</td></tr> <tr><td>Batterie rechargeable</td><td>DC 3.7 V, 3 x 2200 mAh (Li-Ion)</td><td>DC 3.7 V, 3 x 2200 mAh (Li-Ion)</td></tr> <tr><td>Temps de charge avec chargeur</td><td>5-7 h</td><td>5-7 h</td></tr> <tr><td>Durée</td><td>Env. 9 heures (luminosité 100%)</td><td>Env. 9 heures (luminosité 100%)</td></tr> <tr><td>Chargeur</td><td>100-240 VAC, 50/60 Hz, Vout 5 V, 1 A</td><td>100-240 VAC, 50/60 Hz, Vout 5 V, 1 A</td></tr> <tr><td>Catégorie</td><td>III (Luminaire), II (Adaptateur)</td><td>III (Luminaire), II (Adaptateur)</td></tr> <tr><td>Pour Utilisation Intérieure</td><td>Chargeur</td><td>Chargeur</td></tr> <tr><td>Pour Utilisation Extérieure</td><td>IP54 (Luminaire)</td><td>IP54 (Luminaire)</td></tr> </table>	Matériaux	Aluminium	Aluminium	Couleur	Blanc mat	Anthracite mat	Dimensions	Ø29 x H138 cm	Ø29 x H138 cm	Poids	6,4 Kg	6,4 Kg	Support de Lampe	Unité à LED intégrée (amovible)	Unité à LED intégrée (amovible)	Ampoule	LEDs (dimmbable)/ 468 lm/ 3000K, blanc chaud / max. 4,5 W	LEDs (dimmbable)/ 468 lm/ 3000K, blanc chaud / max. 4,5 W	Batterie rechargeable	DC 3.7 V, 3 x 2200 mAh (Li-Ion)	DC 3.7 V, 3 x 2200 mAh (Li-Ion)	Temps de charge avec chargeur	5-7 h	5-7 h	Durée	Env. 9 heures (luminosité 100%)	Env. 9 heures (luminosité 100%)	Chargeur	100-240 VAC, 50/60 Hz, Vout 5 V, 1 A	100-240 VAC, 50/60 Hz, Vout 5 V, 1 A	Catégorie	III (Luminaire), II (Adaptateur)	III (Luminaire), II (Adaptateur)	Pour Utilisation Intérieure	Chargeur	Chargeur	Pour Utilisation Extérieure	IP54 (Luminaire)	IP54 (Luminaire)
Matériaux	Aluminium	Aluminium																																																																														
Couleur	Blanc mat	Anthracite mat																																																																														
Dimensions	Ø29 x H138 cm	Ø29 x H138 cm																																																																														
Poids	6,4 Kg	6,4 Kg																																																																														
Support de Lampe	Unité à LED intégrée (amovible)	Unité à LED intégrée (amovible)																																																																														
Ampoule	LEDs (dimmbable)/ 468 lm/ 3000K, blanc chaud / max. 4,5 W	LEDs (dimmbable)/ 468 lm/ 3000K, blanc chaud / max. 4,5 W																																																																														
Batterie rechargeable	DC 3.7 V, 3 x 2200 mAh (Li-Ion)	DC 3.7 V, 3 x 2200 mAh (Li-Ion)																																																																														
Temps de charge avec chargeur	5-7 h	5-7 h																																																																														
Durée	Env. 9 heures (luminosité 100%)	Env. 9 heures (luminosité 100%)																																																																														
Chargeur	100-240 VAC, 50/60 Hz, Vout 5 V, 1 A	100-240 VAC, 50/60 Hz, Vout 5 V, 1 A																																																																														
Catégorie	III (Luminaire), II (Adaptateur)	III (Luminaire), II (Adaptateur)																																																																														
Pour Utilisation Intérieure	Chargeur	Chargeur																																																																														
Pour Utilisation Extérieure	IP54 (Luminaire)	IP54 (Luminaire)																																																																														
Matériaux	Aluminium	Aluminium																																																																														
Couleur	Blanc mat	Anthracite mat																																																																														
Dimensions	Ø29 x H138 cm	Ø29 x H138 cm																																																																														
Poids	6,4 Kg	6,4 Kg																																																																														
Support de Lampe	Unité à LED intégrée (amovible)	Unité à LED intégrée (amovible)																																																																														
Ampoule	LEDs (dimmbable)/ 468 lm/ 3000K, blanc chaud / max. 4,5 W	LEDs (dimmbable)/ 468 lm/ 3000K, blanc chaud / max. 4,5 W																																																																														
Batterie rechargeable	DC 3.7 V, 3 x 2200 mAh (Li-Ion)	DC 3.7 V, 3 x 2200 mAh (Li-Ion)																																																																														
Temps de charge avec chargeur	5-7 h	5-7 h																																																																														
Durée	Env. 9 heures (luminosité 100%)	Env. 9 heures (luminosité 100%)																																																																														
Chargeur	100-240 VAC, 50/60 Hz, Vout 5 V, 1 A	100-240 VAC, 50/60 Hz, Vout 5 V, 1 A																																																																														
Catégorie	III (Luminaire), II (Adaptateur)	III (Luminaire), II (Adaptateur)																																																																														
Pour Utilisation Intérieure	Chargeur	Chargeur																																																																														
Pour Utilisation Extérieure	IP54 (Luminaire)	IP54 (Luminaire)																																																																														



Modell | Model | Modèle

ISA-BELLE

44-01-01



DE Material	Stahl/Kunststoff
Farbe	Grau
Maße Stehleuchte	B145 x T48 x H190 cm
Maße Bogenleuchte	B58 x T48 x H172 cm
Gewicht Stehleuchte/Bogenleuchte	20 kg / 20 kg
LED-Einheit	ausbaubar
Leuchtmittel/lm/Kelvin/Watt	LEDs (Dimmbar 20-35-70-100%)/ 800 lm/3000K, warmweiß/max. 6 W
Aufladbarer Akku	DC 3.7 V, 3 x 2200 mAh (Li-Ion)
Ladezeit mit Ladegerät/Sonnenschein	Ladegerät ca. 10 Std/ Sonne 16 Std
Laufzeit	Ca. 8-20 Std (20-100% Helligkeit)
Ladegerät/Solarpanel	Vout 5 V, 1 A / 3 W
Verkabelung	2,5 m, weiss
Schutzklasse	III (Leuchte), II (Ladegerät)
Für Innenbereich	Ladegerät
Für Aussenbereich	IP54 (Leuchte)

EN Material	Steel/plastic
Colour	Grey
Dimensions	W145 x D48 x H190 cm W58 x D48 x H172 cm
Weight	20 kg / 20 kg
LED-Unit	Removable
Illuminant	LEDs (dimmable 20-35-70-100%)/ 800 lm/3000K, warmwhite/max. 6 W
Rechargeable battery	DC 3.7 V, 3 x 2200 mAh (Li-Ion)
Charging time adapter/ Sunshine	Adapter approx. 10 h/ Sunshine 16 h
Runtime	Approx. 8-20 Std (20-100% brightness)
Adapter/Solar panel	Vout 5 V, 1 A / 3 W
Cable	2.5 m, white
Protection Class	III (Luminaire), II (Adapter)
For Indoor Use	Adapter
For Outdoor Use	IP54 (Luminaire)

FR Matériaux	Acier/plastique
Couleur	Blanc mat
Dimensions	L145 x L48 x H190 cm L58 x L48 x H172 cm
Poids	20 kg / 20 kg
Unité DEL	Démontable
Ampoule	LEDs (dimmable 20-35-70-100%)/ 800 lm/3000K, blanc chaud/max. 6 W
Batterie rechargeable	DC 3.7 V, 3 x 2200 mAh (Li-Ion)
Temps de charge avec chargeur/soleil	Chargeur env. 10 h/ soleil 16 h
Durée	Env. 8-20 h (20-100% luminosité)
Chargeur/Panneau solaire	Vout 5 V, 1 A / 3 W
Câblage	2,5 m, blanc
Catégorie	III (Luminaire), II (chargeur)
Pour Utilisation Intérieure	Chargeur
Pour Utilisation Extérieure	IP54 (Luminaire)

SWAP 150



SWAP ist auch mit mehrfarbigem/weißem Leuchtmittel erhältlich, siehe RGB-Leuchtmittel Mod. 20-02-01 oder Mod. 20-03-01

SWAP is also available with multicolor/white bulb, refer to RGB bulb Mod. 20-02-01 or Mod. 20-03-01

SWAP est également disponible avec la lumière multicolore/ blanche, référez-vous à Ampoule RGB Mod. 20-02-01 ou Mod. 20-03-01

Modell | Model | Modèle

SWAP OUTDOOR

31-0X-150



DE	Material	PE transluzent, Metallgestell
	Farbe	Mattweiß
	Maße	ca. Ø 35 cm, H 150 cm
	Gewicht	ca. 7 kg
	Lampenfassung	1x E27/max. 40 W E27
	Leuchtmittel	E27
	Fernbedienung	-
	Ladegerät	-
	Verkabelung	Ca. 3 m, schwarz
	Spannung	230 V~, 50 Hz
	Schutzklasse	II
	Für Aussenbereich	IP44

EN	Material	PE translucent shade, metal stand
	Colour	White matte
	Dimensions	approx. Ø 35 cm, H 150 cm
	Weight	approx. 7 kg
	Lamp Holder	1x E27/max. 40 W E27
	Illuminant	E27
	Remote Control	-
	Charger	-
	Cable	Approx. 3 m, black
	Voltage	230 V~, 50 Hz
	Protection Class	II
	For Outdoor Use	IP44

FR	Matériaux	PE translucide, support en métal
	Couleur	Blanc satiné
	Dimensions	Env. Ø 35 cm, H 150 cm
	Poids	Env. 7 kg
	Support de Lampe	1x E27/max. 40 W E27
	Ampoule	E27
	Télécommande	-
	Chargeur	-
	Câblage	Env. 3 m, noir
	Tension	230 V~, 50 Hz
	Catégorie	II
	Pour Utilisation Extérieure	IP44

SWAP SHADES



Modell	31-01-01 Blaue Linien
	31-02-01 Grüner Dschungel
	31-03-01 Grau Quatrefoil
	31-04-01 Rosa Chevron
	31-05-01 Silberne Sterne
	31-06-01 Kunststoffgewebe, grau
Material	PE
Maße	Ø 34,5 x H 29 cm
Gewicht	0.12 kg

Model	31-01-01 Royal blue lines
	31-02-01 Hunter green jungle
	31-03-01 Cool grey quatrefoil
	31-04-01 Rose pink chevron
	31-05-01 Stars on silver
	31-06-01 Grey coated fabric
Material	PE
Dims.	Ø 34.5 x H 29 cm
Weight	0.12 kg

Modèle	31-01-01 Lignes bleues
	31-02-01 Jungle verte
	31-03-01 Gris quatrefoil
	31-04-01 Rose chevron
	31-05-01 Étoiles d'argent
	31-06-01 Tissu en plastique gris
Matériaux	PE
Dims.	Ø 34,5 x H 29 cm
Poids	0.12 kg

SWAP 150 & SHADES

SWAP + ROYAL BLUE LINES
31-01-150



SWAP + HUNTER GREEN JUNGLE
31-02-150



SWAP + COOL GREY QUATREFOIL
31-03-150



ROYAL BLUE LINES
31-01-01



HUNTER GREEN JUNGLE
31-02-01



COOL GREY QUATREFOIL
31-03-01



SWAP + ROSE PINK CHEVRON
31-04-150



SWAP + SILVER STARS
31-05-150



SWAP + GREY COATED FABRIC
31-06-150



SWAP
31-00-150



Leuchte ohne Design-Lampenschirm
Lamp without design shade cover
Lampe sans abat-jour

ROSE PINK CHEVRON
31-04-01



SILVER STARS
31-05-01









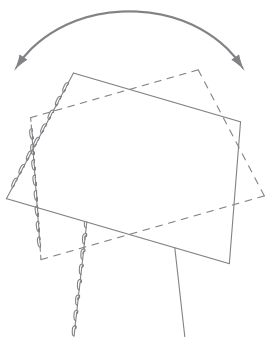

GREY COATED FABRIC
31-06-01



ALICE XL











- Mit schwenkbarem Schirm
 - With tiltable head
 - Avec tête inclinable

Modell Model Modèle	ALICE XL 29-02-01	ALICE XL LED 29-02-01-LED																																																								
	  	    																																																								
DE	<table border="1"> <tr><td>Material</td><td>Filz (PE)</td></tr> <tr><td>Farbe</td><td>Grau</td></tr> <tr><td>Maße</td><td>Ø 70 cm, H 172 cm</td></tr> <tr><td>Maße Schirm</td><td>Ø 70 cm, H 40 cm</td></tr> <tr><td>Gewicht</td><td>15,8 Kg</td></tr> <tr><td>Lampenfassung</td><td>1x E27/ max. 40 W E27</td></tr> <tr><td>Leuchtmittel</td><td>LED Leuchtmittel E27, max. 5,5 W, EEK: F, max. 500 lm Lebensdauer: 15.000 h</td></tr> <tr><td>Fernbedienung</td><td>-</td></tr> <tr><td>Aufladbarer Akku/ Ladezeit Laufzeit (in Farbwechsel)</td><td>-</td></tr> <tr><td>Ladegerät</td><td>-</td></tr> <tr><td>Verkabelung</td><td>2,2 m, transluzent</td></tr> <tr><td>Spannung</td><td>230 V~, 50 Hz</td></tr> <tr><td>Schutzklasse</td><td>II</td></tr> <tr><td>Für Innenbereich</td><td>Ja</td></tr> </table>	Material	Filz (PE)	Farbe	Grau	Maße	Ø 70 cm, H 172 cm	Maße Schirm	Ø 70 cm, H 40 cm	Gewicht	15,8 Kg	Lampenfassung	1x E27/ max. 40 W E27	Leuchtmittel	LED Leuchtmittel E27, max. 5,5 W, EEK: F, max. 500 lm Lebensdauer: 15.000 h	Fernbedienung	-	Aufladbarer Akku/ Ladezeit Laufzeit (in Farbwechsel)	-	Ladegerät	-	Verkabelung	2,2 m, transluzent	Spannung	230 V~, 50 Hz	Schutzklasse	II	Für Innenbereich	Ja	<table border="1"> <tr><td>Material</td><td>Filz (PE)</td></tr> <tr><td>Farbe</td><td>Grau</td></tr> <tr><td>Maße</td><td>Ø 70 cm, H 172 cm</td></tr> <tr><td>Maße Schirm</td><td>Ø 70 cm, H 40 cm</td></tr> <tr><td>Gewicht</td><td>15,8 Kg</td></tr> <tr><td>Lampenfassung</td><td>1x E27/ max. 40 W E27</td></tr> <tr><td>Leuchtmittel</td><td>Multicolor LED Leuchtmittel E27, max. 9 W, EEK: F, max. 850 lm Lebensdauer: 50.000 h</td></tr> <tr><td>Fernbedienung</td><td>mit Funkfernbedienung</td></tr> <tr><td>Aufladbarer Akku/ Ladezeit Laufzeit (in Farbwechsel)</td><td>-</td></tr> <tr><td>Ladegerät</td><td>-</td></tr> <tr><td>Verkabelung</td><td>2,2 m, transluzent</td></tr> <tr><td>Spannung</td><td>230 V~, 50 Hz</td></tr> <tr><td>Schutzklasse</td><td>II</td></tr> <tr><td>Für Innenbereich</td><td>Ja</td></tr> </table>	Material	Filz (PE)	Farbe	Grau	Maße	Ø 70 cm, H 172 cm	Maße Schirm	Ø 70 cm, H 40 cm	Gewicht	15,8 Kg	Lampenfassung	1x E27/ max. 40 W E27	Leuchtmittel	Multicolor LED Leuchtmittel E27, max. 9 W, EEK: F, max. 850 lm Lebensdauer: 50.000 h	Fernbedienung	mit Funkfernbedienung	Aufladbarer Akku/ Ladezeit Laufzeit (in Farbwechsel)	-	Ladegerät	-	Verkabelung	2,2 m, transluzent	Spannung	230 V~, 50 Hz	Schutzklasse	II	Für Innenbereich	Ja
Material	Filz (PE)																																																									
Farbe	Grau																																																									
Maße	Ø 70 cm, H 172 cm																																																									
Maße Schirm	Ø 70 cm, H 40 cm																																																									
Gewicht	15,8 Kg																																																									
Lampenfassung	1x E27/ max. 40 W E27																																																									
Leuchtmittel	LED Leuchtmittel E27, max. 5,5 W, EEK: F, max. 500 lm Lebensdauer: 15.000 h																																																									
Fernbedienung	-																																																									
Aufladbarer Akku/ Ladezeit Laufzeit (in Farbwechsel)	-																																																									
Ladegerät	-																																																									
Verkabelung	2,2 m, transluzent																																																									
Spannung	230 V~, 50 Hz																																																									
Schutzklasse	II																																																									
Für Innenbereich	Ja																																																									
Material	Filz (PE)																																																									
Farbe	Grau																																																									
Maße	Ø 70 cm, H 172 cm																																																									
Maße Schirm	Ø 70 cm, H 40 cm																																																									
Gewicht	15,8 Kg																																																									
Lampenfassung	1x E27/ max. 40 W E27																																																									
Leuchtmittel	Multicolor LED Leuchtmittel E27, max. 9 W, EEK: F, max. 850 lm Lebensdauer: 50.000 h																																																									
Fernbedienung	mit Funkfernbedienung																																																									
Aufladbarer Akku/ Ladezeit Laufzeit (in Farbwechsel)	-																																																									
Ladegerät	-																																																									
Verkabelung	2,2 m, transluzent																																																									
Spannung	230 V~, 50 Hz																																																									
Schutzklasse	II																																																									
Für Innenbereich	Ja																																																									
EN	<table border="1"> <tr><td>Material</td><td>Felt (PE)</td></tr> <tr><td>Colour</td><td>Grey</td></tr> <tr><td>Dimensions</td><td>Ø 70 cm, H 172 cm</td></tr> <tr><td>Dimensions Shade</td><td>Ø 70 cm, H 40 cm</td></tr> <tr><td>Weight</td><td>15,8 Kg</td></tr> <tr><td>Lamp Holder</td><td>1x E27/ max. 40 W E27</td></tr> <tr><td>Illuminant</td><td>LED bulb E27, max. 5,5 W, EEC: F, max. 500 lm Life span: 15.000 h</td></tr> <tr><td>Remote Control</td><td>-</td></tr> <tr><td>Rechargeable battery/ Charging Time Runtime (in colour change)</td><td>-</td></tr> <tr><td>Charger</td><td>-</td></tr> <tr><td>Cable</td><td>2,2 m, translucent</td></tr> <tr><td>Voltage</td><td>230 V~, 50 Hz</td></tr> <tr><td>Protection Class</td><td>II</td></tr> <tr><td>For Indoor Use</td><td>Yes</td></tr> </table>	Material	Felt (PE)	Colour	Grey	Dimensions	Ø 70 cm, H 172 cm	Dimensions Shade	Ø 70 cm, H 40 cm	Weight	15,8 Kg	Lamp Holder	1x E27/ max. 40 W E27	Illuminant	LED bulb E27, max. 5,5 W, EEC: F, max. 500 lm Life span: 15.000 h	Remote Control	-	Rechargeable battery/ Charging Time Runtime (in colour change)	-	Charger	-	Cable	2,2 m, translucent	Voltage	230 V~, 50 Hz	Protection Class	II	For Indoor Use	Yes	<table border="1"> <tr><td>Material</td><td>Felt (PE)</td></tr> <tr><td>Colour</td><td>Grey</td></tr> <tr><td>Dimensions</td><td>Ø 70 cm, H 172 cm</td></tr> <tr><td>Dimensions Shade</td><td>Ø 70 cm, H 40 cm</td></tr> <tr><td>Weight</td><td>15,8 Kg</td></tr> <tr><td>Lamp Holder</td><td>1x E27/ max. 40 W E27</td></tr> <tr><td>Illuminant</td><td>LED multicolour light bulb E27, max. 9 W, EEC: F, max. 850 lm, Life span: 50.000 h</td></tr> <tr><td>Remote Control</td><td>with Radio remote control</td></tr> <tr><td>Rechargeable battery/ Charging Time Runtime (in colour change)</td><td>-</td></tr> <tr><td>Charger</td><td>-</td></tr> <tr><td>Cable</td><td>2,2 m, translucent</td></tr> <tr><td>Voltage</td><td>230 V~, 50 Hz</td></tr> <tr><td>Protection Class</td><td>II</td></tr> <tr><td>For Indoor Use</td><td>Yes</td></tr> </table>	Material	Felt (PE)	Colour	Grey	Dimensions	Ø 70 cm, H 172 cm	Dimensions Shade	Ø 70 cm, H 40 cm	Weight	15,8 Kg	Lamp Holder	1x E27/ max. 40 W E27	Illuminant	LED multicolour light bulb E27, max. 9 W, EEC: F, max. 850 lm, Life span: 50.000 h	Remote Control	with Radio remote control	Rechargeable battery/ Charging Time Runtime (in colour change)	-	Charger	-	Cable	2,2 m, translucent	Voltage	230 V~, 50 Hz	Protection Class	II	For Indoor Use	Yes
Material	Felt (PE)																																																									
Colour	Grey																																																									
Dimensions	Ø 70 cm, H 172 cm																																																									
Dimensions Shade	Ø 70 cm, H 40 cm																																																									
Weight	15,8 Kg																																																									
Lamp Holder	1x E27/ max. 40 W E27																																																									
Illuminant	LED bulb E27, max. 5,5 W, EEC: F, max. 500 lm Life span: 15.000 h																																																									
Remote Control	-																																																									
Rechargeable battery/ Charging Time Runtime (in colour change)	-																																																									
Charger	-																																																									
Cable	2,2 m, translucent																																																									
Voltage	230 V~, 50 Hz																																																									
Protection Class	II																																																									
For Indoor Use	Yes																																																									
Material	Felt (PE)																																																									
Colour	Grey																																																									
Dimensions	Ø 70 cm, H 172 cm																																																									
Dimensions Shade	Ø 70 cm, H 40 cm																																																									
Weight	15,8 Kg																																																									
Lamp Holder	1x E27/ max. 40 W E27																																																									
Illuminant	LED multicolour light bulb E27, max. 9 W, EEC: F, max. 850 lm, Life span: 50.000 h																																																									
Remote Control	with Radio remote control																																																									
Rechargeable battery/ Charging Time Runtime (in colour change)	-																																																									
Charger	-																																																									
Cable	2,2 m, translucent																																																									
Voltage	230 V~, 50 Hz																																																									
Protection Class	II																																																									
For Indoor Use	Yes																																																									
FR	<table border="1"> <tr><td>Matériaux</td><td>Feutre (PE)</td></tr> <tr><td>Couleur</td><td>Gris</td></tr> <tr><td>Dimensions</td><td>Ø 70 cm, H 172 cm</td></tr> <tr><td>Abat-Jour</td><td>Ø 70 cm, H 40 cm</td></tr> <tr><td>Poids</td><td>15,8 Kg</td></tr> <tr><td>Support de Lampe</td><td>1x E27/ max. 40 W E27</td></tr> <tr><td>Ampoule</td><td>illuminant à DEL E27, max. 5,5 W, CÉ: F, max. 500 lm Durée de vie: 15.000 h</td></tr> <tr><td>Télécommande</td><td>-</td></tr> <tr><td>Batterie/ Temps de Charge Autonomie (en changement de couleur)</td><td>-</td></tr> <tr><td>Chargeur</td><td>-</td></tr> <tr><td>Câblage</td><td>2,2 m, transparent</td></tr> <tr><td>Tension</td><td>230 V~, 50 Hz</td></tr> <tr><td>Catégorie</td><td>II</td></tr> <tr><td>Pour Utilisation Intérieur</td><td>Oui</td></tr> </table>	Matériaux	Feutre (PE)	Couleur	Gris	Dimensions	Ø 70 cm, H 172 cm	Abat-Jour	Ø 70 cm, H 40 cm	Poids	15,8 Kg	Support de Lampe	1x E27/ max. 40 W E27	Ampoule	illuminant à DEL E27, max. 5,5 W, CÉ: F, max. 500 lm Durée de vie: 15.000 h	Télécommande	-	Batterie/ Temps de Charge Autonomie (en changement de couleur)	-	Chargeur	-	Câblage	2,2 m, transparent	Tension	230 V~, 50 Hz	Catégorie	II	Pour Utilisation Intérieur	Oui	<table border="1"> <tr><td>Matériaux</td><td>Feutre (PE)</td></tr> <tr><td>Couleur</td><td>Gris</td></tr> <tr><td>Dimensions</td><td>Ø 70 cm, H 172 cm</td></tr> <tr><td>Abat-Jour</td><td>Ø 70 cm, H 40 cm</td></tr> <tr><td>Poids</td><td>15,8 Kg</td></tr> <tr><td>Support de Lampe</td><td>1x E27/ max. 40 W E27</td></tr> <tr><td>Ampoule</td><td>LED multicolours E27, max. 9 W, CÉ: F, max. 850 lm, Durée de vie: 50.000 h</td></tr> <tr><td>Télécommande</td><td>avec télécommande radio</td></tr> <tr><td>Batterie/ Temps de Charge Autonomie (en changement de couleur)</td><td>-</td></tr> <tr><td>Chargeur</td><td>-</td></tr> <tr><td>Câblage</td><td>2,2 m, transparent</td></tr> <tr><td>Tension</td><td>230 V~, 50 Hz</td></tr> <tr><td>Catégorie</td><td>II</td></tr> <tr><td>Pour Utilisation Intérieur</td><td>Oui</td></tr> </table>	Matériaux	Feutre (PE)	Couleur	Gris	Dimensions	Ø 70 cm, H 172 cm	Abat-Jour	Ø 70 cm, H 40 cm	Poids	15,8 Kg	Support de Lampe	1x E27/ max. 40 W E27	Ampoule	LED multicolours E27, max. 9 W, CÉ: F, max. 850 lm, Durée de vie: 50.000 h	Télécommande	avec télécommande radio	Batterie/ Temps de Charge Autonomie (en changement de couleur)	-	Chargeur	-	Câblage	2,2 m, transparent	Tension	230 V~, 50 Hz	Catégorie	II	Pour Utilisation Intérieur	Oui
Matériaux	Feutre (PE)																																																									
Couleur	Gris																																																									
Dimensions	Ø 70 cm, H 172 cm																																																									
Abat-Jour	Ø 70 cm, H 40 cm																																																									
Poids	15,8 Kg																																																									
Support de Lampe	1x E27/ max. 40 W E27																																																									
Ampoule	illuminant à DEL E27, max. 5,5 W, CÉ: F, max. 500 lm Durée de vie: 15.000 h																																																									
Télécommande	-																																																									
Batterie/ Temps de Charge Autonomie (en changement de couleur)	-																																																									
Chargeur	-																																																									
Câblage	2,2 m, transparent																																																									
Tension	230 V~, 50 Hz																																																									
Catégorie	II																																																									
Pour Utilisation Intérieur	Oui																																																									
Matériaux	Feutre (PE)																																																									
Couleur	Gris																																																									
Dimensions	Ø 70 cm, H 172 cm																																																									
Abat-Jour	Ø 70 cm, H 40 cm																																																									
Poids	15,8 Kg																																																									
Support de Lampe	1x E27/ max. 40 W E27																																																									
Ampoule	LED multicolours E27, max. 9 W, CÉ: F, max. 850 lm, Durée de vie: 50.000 h																																																									
Télécommande	avec télécommande radio																																																									
Batterie/ Temps de Charge Autonomie (en changement de couleur)	-																																																									
Chargeur	-																																																									
Câblage	2,2 m, transparent																																																									
Tension	230 V~, 50 Hz																																																									
Catégorie	II																																																									
Pour Utilisation Intérieur	Oui																																																									





	SHARK INDOOR 26-01-01	SHARK INDOOR LED 26-01-01-LED
Modell Model Modèle	26-01-01	26-01-01-LED
	  	    
Maße Dimensions Dimensions	ca. approx. env. 70 x 19.5 x 65 cm	ca. approx. env. 70 x 19.5 x 65 cm
Gewicht Weight Poids	ca. approx. env. 2.5 kg	ca. approx. env. 2.5 kg
DE Material	PE seidenmatt, UV-beständig	PE seidenmatt, UV-beständig
Farbe	Weiß, transluzent	Weiß, transluzent
Lampenfassung	1x E27/ max. 40 W E27	1x E27/ max. 40 W E27
Leuchtmittel	LED Leuchtmittel E27, max. 5,5 W, EEC: F, max. 500 lm Lebensdauer: 15.000 h	Multicolor LED Leuchtmittel E27, max. 9 W, EEC: F, max. 850 lm Lebensdauer: 50.000 h
Fernbedienung	-	mit Funkfernbedienung
Aufladbarer Akku/ Ladezeit Laufzeit (in Farbwechsel)	-	-
Ladegerät	-	-
Verkabelung	ca. 2,6 m mit Fußschalter, klar	ca. 2,6 m mit Fußschalter, klar
Spannung	230 V~, 50 Hz	230 V~, 50 Hz
Schutzklasse	II	II
Für Innenbereich	Ja	Ja
Für Aussenbereich	-	-
EN Material	PE semi gloss, UV resistant	PE semi gloss, UV resistant
Colour	White, translucent	White, translucent
Lamp Holder	1x E27/ max. 40 W E27	1x E27/ max. 40 W E27
Illuminant	LED bulb E27, max. 5,5 W, EEC: F, max. 500 lm Life span: 15.000 h	LED multicolour light bulb E27, max. 9 W, EEC: F, max. 850 lm, Life span: 50.000 h
Remote Control	-	with Radio remote control
Rechargeable battery/ Charging Time Runtime (in colour change)	-	-
Charger	-	-
Cable	approx. 2.6 m cable, clear	approx. 2.6 m cable, clear
Voltage	230 V~, 50 Hz	230 V~, 50 Hz
Protection Class	II	II
For Indoor Use	Yes	Yes
For Outdoor Use	-	-
FR Matériaux	PE satiné, résistant aux rayons UV	PE satiné, résistant aux rayons UV
Couleur	Blanc, translucide	Blanc, translucide
Support de Lampe	1x E27/ max. 40 W E27	1x E27/ max. 40 W E27
Ampoule	Illuminant à DEL E27, max. 5,5 W, CÉ: F, max. 500 lm Durée de vie: 15.000 h	LED multicolours E27, max. 9 W, CÉ: F, max. 850 lm, Durée de vie: 50.000 h
Télécommande	-	avec télécommande radio
Batterie/ Temps de Charge Autonomie (en changement de couleur)	-	-
Chargeur	-	-
Câblage	env. 2.6 m, transparent	env. 2.6 m, transparent
Tension	230 V~, 50 Hz	230 V~, 50 Hz
Catégorie	II	II
Pour Utilisation Intérieur	Oui	Oui
Pour Utilisation Extérieure	-	-

SHARK OUTDOOR

26-02-01



ca. | approx. | env. 70 x 19.5 x 65 cm

ca. | approx. | env. 3.2 kg

PE seidenmatt, UV-beständig

Weiß, transluzent

1x E27/ max. 40 W E27

LED Leuchtmittel E27,
max. 5,5 W, EEK: F, max. 500 lm
Lebensdauer: 15.000 h

-

-

-

ca. 4,6 m, schwarz

230 V~, 50 Hz

II

-

-

IP44

SHARK OUTDOOR LED

26-02-01-LED



ca. | approx. | env. 70 x 19.5 x 65 cm

ca. | approx. | env. 3.2 kg

PE seidenmatt, UV-beständig

Weiß, transluzent

1x E27/ max. 40 W E27

Multicolor LED Leuchtmittel E27,
max. 9 W, EEK: F, max. 850 lm
Lebensdauer: 50.000 h

mit Funkfernbedienung

-

-

ca. 4,6 m, schwarz

230 V~, 50 Hz

II

-

-

IP44

SHARK OUTDOOR LED ACCU

26-03-01



ca. | approx. | env. 70 x 19.5 x 65 cm

ca. | approx. | env. 2.5 kg

PE seidenmatt, UV-beständig

Weiß, transluzent

EINGEBAUTE LED-Einheit (ausbaubar)

Multicolor & Warmweiß 2700 K,
Kaltweiß 6000 K LEDs, max. 7,2 W,
max. 810 lm, Lebensdauer: 30000 h

IR

3.7 V, 2 x 2600 mAh (Li-Ion)/ 10 Std.
11 Std.

100-240 V~, 50/60 Hz, Vout 5 V, 1,2 A

1,2 m

100-240 VAC, 50/60 Hz

III (Produkt), II (Ladegerät)

-

-

IP54

PE semi gloss, UV resistant

White, translucent

1x E27/ max. 40 W E27

LED bulb E27,
max. 5,5 W, EEC: F, max. 500 lm
Life span: 15.000 h

-

-

-

approx. 4.6 m, black

230 V~, 50 Hz

II

-

-

IP 44

PE semi gloss, UV resistant

White, translucent

1x E27/ max. 40 W E27

LED multicolour light bulb E27,
max. 9 W, EEC: F, max. 850 lm,
Life span: 50.000 h

with Radio remote control

-

-

approx. 4.6 m, black

230 V~, 50 Hz

II

-

-

IP 44

PE semi gloss, UV resistant

White, translucent

Built-In LED Unit (removable)

Multicolor & warm white 2700 K,
cool white 6000 K LEDs, max. 7.2 W,
max. 810 lm, life span: 30000 h

IR

3.7 V, 2 x 2600 mAh (Li-Ion)/ 10 Std.
11 Std.

100-240 V~, 50/60 Hz, Vout 5 V, 1,2 A

1,2 m

100-240 VAC, 50/60 Hz

III (Product), II (Charger)

-

-

IP 54

PE satiné, résistant aux rayons UV

Blanc, translucide

1x E27/ max. 40 W E27

illuminant à DEL E27,
max. 5,5 W, CE: F, max. 500 lm
Durée de vie: 15.000 h

-

-

-

env. 4,6 m, noir

230 V~, 50Hz

II

-

-

IP44

PE satiné, résistant aux rayons UV

Blanc, translucide

1x E27/ max. 40 W E27

LED multicolours E27,
max. 9 W, CE: F, max. 850 lm,
Durée de vie: 50.000 h

avec télécommande radio

-

-

env. 4,6 m, noir

230 V~, 50 Hz

II

-

-

IP44

PE satiné, résistant aux rayons UV

Blanc, translucide

Unité à LED intégrée (amovible)

DEL multicolores & blanc chaud 2700
K, blanc froid 6000 K, max. 7,2 W,
max. 810 lm, durée de vie: 30000 h

IR

3.7 V, 2 x 2600 mAh (Li-Ion)/ 10 Std.
11 Std.

100-240 V~, 50/60 Hz, Vout 5 V, 1,2 A

1,2 m

100-240 VAC, 50/60 Hz

III (Produit), II (Chargeur)

-

-

IP54

STAR 40 | STAR 60



	STAR 40 LED OUTDOOR MOD. 05-04-40	STAR 60 LED OUTDOOR MOD. 05-04-60
Modell Model Modèle	MOD. 05-04-40	MOD. 05-04-60
DE		
Material	PE, matt	PE, matt
Farbe	Weiß, transluzent	Weiß, transluzent
Maße	B 41 x L 10 x H 40	B 57 x L 13 x H 55 cm
Gewicht	1 kg	2 Kg
Lampenfassung	EINGEBAUTE LED-Einheit (ausbaubar)	EINGEBAUTE LED-Einheit (ausbaubar)
Leuchtmittel	Multicolor-LEDs, max. 3 W, max. 142 lm, EEK: G Lebensdauer: 30000 h	Multicolor-LEDs, max. 3 W, max. 168 lm, EEK: G Lebensdauer: 30000 h
Fernbedienung	IR	IR
Aufladbarer Akku/ Ladezeit Laufzeit (in Farbwechsel)	-	-
Ladegerät/ Kabel	-	-
Verkabelung	1,8 m, schwarz	1,8 m, schwarz
Spannung	100-240 VAC, 50/60 Hz, Vout 5 V, 1 A	100-240 VAC, 50/60 Hz, Vout 5 V, 1 A
Schutzklasse	III (Produkt), II (Netzteil)	III (Produkt), II (Netzteil)
Für Außenbereich	IP44	IP44
EN		
Material	PE matte finish	PE matte finish
Colour	White, translucent	White, translucent
Dimensions	W41 x L 10 x H 40	W57 x L 13 x H 55 cm
Weight	1 kg	2 Kg
Lamp Holder	Built-In LED Unit (removable)	Built-In LED Unit (removable)
Illuminant	Multicolour LEDs, max. 3 W, max. 142 lm, EEC: G life span: 30000 h	Multicolour LEDs, max. 3 W, max. 168 lm, EEC: G life span: 30000 h
Remote Control	IR	IR
Rechargeable battery/ ChargingTime Runtime (in colour change)	-	-
Charger/ Cable	-	-
Cable	1,8 m, black	1,8 m, black
Voltage	100-240 VAC, 50/60 Hz, Vout 5 V, 1 A	100-240 VAC, 50/60 Hz, Vout 5 V, 1 A
Protection Class	III (Product), II (Charger)	III (Product), II (Charger)
For Outdoor Use	IP44	IP44
FR		
Matériaux	PE matte finition	PE matte finition
Couleur	Blanc, translucide	Blanc, translucide
Dimensions	La 41 x L 10 x H 40	La 57 x L 13 x H 55 cm
Poids	1 kg	2 Kg
Support de Lampe	Unité à LED intégrée (amovible)	Unité à LED intégrée (amovible)
Ampoule	Multicolore LED, max. 3 W, max. 142 lm, CÉ: G Durée de vie: 30000 h	Multicolore LED, max. 3 W, max. 168 lm, CÉ: G Durée de vie: 30000 h
Télécommande	IR	IR
Batterie/ Temps de Charge Autonomie (en changement de couleur)	-	-
Chargeur/ Câblage	-	-
Câblage	1,8 m, noir	1,8 m, noir
Tension	100-240 VAC, 50/60 Hz, Vout 5 V, 1 A	100-240 VAC, 50/60 Hz, Vout 5 V, 1 A
Catégorie	III (Produit), II (Alimentation électrique)	III (Produit), II (Alimentation électrique)
Pour Utilisation Extérieure	IP44	IP44

STAR 40 LED ACCU OUTDOOR

MOD. 05-02-40



PE, matt
Weiß, transluzent
B 41 x L 10 x H 40
1 kg
EINGEBAUTE LED-Einheit (ausbaubar)
Multicolor-LEDs, max. 3 W, max. 142 lm, EEK: G Lebensdauer: 30000 h
IR
3,7 V austauschbar, 6 h 7 h
Vout 5 V, 1 A/ 1,8 m, weiß
-
110-240 V~, 50-60 Hz
III (Produkt), II (Ladegerät)
IP44

PE matte finish
White, translucent
W41 x L 10 x H 40
1 kg
Built-In LED Unit (removable)
Multicolour LEDs, max. 3 W, max. 142 lm, EEC: G life span: 30000 h
IR
3,7 V replaceable, 6 h 7 h
Vout 5 V, 1 A/ 1,8 m, white
-
110-240 V~, 50-60 Hz
III (Product), II (Charger)
IP44

PE matte finition
Blanc, translucide
La41 x L 10 x H40
1 kg
Unité à LED intégrée (amovible)
Multicolore LED, max. 3 W, max. 142 lm, CÉ: G Durée de vie: 30000 h
IR
3,7 V remplaçable, 6 h 7 h
Vout 5 V, 1 A/ 1,8 m, blanc
-
110-240 V~, 50-60 Hz
III (Produit), II (Chargeur)
IP44

STAR 60 LED ACCU OUTDOOR

MOD. 05-02-60



PE, matt
Weiß, transluzent
B 57 x L 13 x H 55 cm
2 Kg
EINGEBAUTE LED-Einheit (ausbaubar)
Multicolor-LEDs, max. 3 W, max. 168 lm, EEK: G Lebensdauer: 30000 h
IR
3,7 V austauschbar, 6 h 7 h
Vout 5 V, 1 A/ 1,8 m, weiß
-
110-240 V~, 50-60 Hz
III (Produkt), II (Ladegerät)
IP44





PE matte finish
White, translucent
W57 x L 13 x H55 cm
2 Kg
Built-In LED Unit (removable)
Multicolour LEDs, max. 3 W, max. 168 lm, EEC: G life span: 30000 h
IR
3,7 V replaceable, 6 h 7 h
Vout 5 V, 1 A/ 1,8 m, white
-
110-240 V~, 50-60 Hz
III (Product), II (Charger)
IP44

PE matte finition
Blanc, translucide
La57 x L 13 x H55 cm
2 Kg
Unité à LED intégrée (amovible)
Multicolore LED, max. 3 W, max. 168 lm, CÉ: G Durée de vie: 30000 h
IR
3,7 V remplaçable, 6 h 7 h
Vout 5 V, 1 A/ 1,8 m, blanc
-
110-240 V~, 50-60 Hz
III (Produit), II (Chargeur)
IP44



9W RGB CCT BULB



	9W MULTICOLOUR LED LIGHTBULB 20-04-01	REMOTE CONTROLLER (2.4 GHZ) 20-02-02
Modell Model Modèle	   	
DE Material	Aluminium, Kunststoff	Kunststoff
Farbe	silber, weiß	weiß
Maße	Ø 74 x 137 mm	B 53 x L x 120 x H 20 mm
Gewicht	ca. 120 gr	53 g
Energieeffizienz-Klasse/ Lumen	F/ Lm: Max. 960 (weiß)	-
Leuchtmittel	RGB CCT (Multicolor & Warm- Kaltweiß 2700 – 6500 K) LED Leuchtmittel E27, MAX. 9 W, Lebensdauer: 50.000 h	-
Fernbedienung/ Batterien	Mod. 20-02-02 wird benötigt/ -	Funk 2.4 GHz/ 2 x AAA (nur Alkaline)
Spannung	100-240 V, 50-60 Hz	-
Funktionen	<ul style="list-style-type: none"> • 9 Programme • Multicolor RGB-Spektrum, Farbsättigung ist einstellbar • Warm- bis kaltweißes Licht von: 2700 bis 6500 K stufenlos justierbar • Dimmfunktion • 4-Kanal-Steuerung • Reichweite bis zu 30 m 	<ul style="list-style-type: none"> • 9 Programme • Multicolor RGB-Spektrum, Farbsättigung ist einstellbar • Warm- bis kaltweißes Licht von: 2700 bis 6500 K stufenlos justierbar • Dimmfunktion • 4-Kanal-Steuerung • Reichweite bis zu 30 m
EN Material	Aluminium, plastic	Plastic
Colour	silver, white	white
Dimensions	approx. Ø 74 x 137 mm	W 53 x L x 120 x H 20 mm
Weight	approx. 0.12 kg	53 g
Energy Class/ Lumens	F/ Lm: Max. 960 (white)	-
Illuminant	RGB CCT (Multicolour & Warm-Cool White 2700 - 6500 K) LED bulb E27, MAX. 9 W, Lifespan: 50.000 h	-
Remote Control/ Battery	Mod. 20-02-02 is needed/ -	Radio 2.4 GHz/ 2 x AAA (Alkaline only)
Voltage	100-240 V, 50-60 Hz	-
Functions	<ul style="list-style-type: none"> • 9 programmes • The entire RGB spectrum, colour saturation is adjustable • Warm to cool white light is settable: 2700 – 6500 K • Dimmable • 4 Channel controls • A range of up to 30 m 	<ul style="list-style-type: none"> • 9 programmes • The entire RGB spectrum, colour saturation is adjustable • Warm to cool white light is settable: 2700 – 6500 K • Dimmable • 4 Channel controls • A range of up to 30 m
FR Matériaux	Aluminium, plastique	Plastique
Couleur	argentée, blanc	blanc
Dimensions	Ø env. 74 mm, H 137 mm	La 53 x Lo x 120 x H 20 mm
Poids	env. 0,12 kg	53 g
Classe Énergétique/ Lumens	F/ Lm: Max. 960 (blanc)	-
Ampoule	Ampoule à DEL RGB CCT (multicolore et blanc chaud-froid 2700 - 6500 K) E27, MAX. 9 W, Durée de vie: 50.000 h	-
Télécommande/ Batterie	Mod. 20-02-02 est nécessaire/ -	Radio contrôle 2.4 GHz/ 2 x AAA (seulement Alcalin)
Tension	100-240 V, 50-60 Hz	-
Fonctions	<ul style="list-style-type: none"> • 9 programmes • L'ensemble du spectre RVB, la saturation des couleurs est réglable • La lumière blanche chaude ou froide est réglable : 2700 - 6500 K • Contrôle d'intensité • 4 Channel controls • Une gamme de jusqu'à 30 m 	<ul style="list-style-type: none"> • 9 programmes • L'ensemble du spectre RVB, la saturation des couleurs est réglable • La lumière blanche chaude ou froide est réglable : 2700 - 6500 K • Contrôle d'intensité • 4 Channel controls • Une gamme de jusqu'à 30 m

11W WIFI RGB CCT BULB



11W RGB CCT LIGHTBULB

Modell | Model | Modèle

20-03-01



DE	Beschreibung	WIFI LED RGB & CCT Leuchtmittel
	Material/ Farbe	Aluminium, weiß/ Kunststoff opak
	Maße/ Gewicht	Ø ca. 70 mm, H 130 mm/ ca. 70 g
	Energieeffizienz-Klasse	F
	Leistung/ Lebensdauer	MAX. 11 W/ 25.000 h
	Spannung/ Lampenhalter	220-240 V, 50 Hz/ E27
	Lichtfarben/ Lumen	Multicolor/ Warm-Kaltweiß einstellbar (2700 - 6500 K), max 1050 lm
	Fernbedienung	Per Smartphone mit Moree Mobile Remote-App (Android & IOS)
	Funktionen	<ul style="list-style-type: none"> • Szenen- und Farbprogramme • Multicolor & Weißlicht-Einstellungen • Eingebautes WLAN-Modul • Zeitschalter per App • Dimm-Funktion per App • Kompatibel mit Google Home und Amazon Echo über Sprachsteuerung
EN	Description	WIFI LED multicolor & white light bulb
	Material/ Colour	Aluminium, white/ plastic, opaque
	Dimensions/ Weight	Ø approx. 70 mm, H 130 mm/ approx. 70 g
	Energy Class	F
	Power/ Lifespan	MAX. 11 W/ 25.000 h
	Voltage/ Lamp holder	220-240 V, 50-60 Hz/ E27
	Light colours/ Lumens	Multicolour/ warm & cold white 2700-6500 K, max 1050 lm
	Remote Control	With smartphone by Moree Mobile Remote app (Android & IOS)
	Functions	<ul style="list-style-type: none"> • Scene and colour programmes • Multicolor & white light settings • Built in wifi controller • Timing switch via app • Dimming function via App • Compatible with voice control via Google home & Amazon Echo
FR	Description	WIFI LED ampoule multicolore & blanche
	Matériaux/ Couleur	Aluminium, blanc/ plastique opaque
	Dimensions/ Poids	Ø env. 70 mm, H 130 mm/ env. 70 g
	Classe Énergétique	F
	Puissance/ Durée de vie	MAX. 11 W/ 25.000 h
	Tension/ Support de lampe	220-240 V, 50 Hz/ E27
	Couleurs de la lumière/ Lumen	Multicolore/ blanc chaud et froid 2700-6500 K, max 1050 lm
	Télécommande	Avec smartphone par l'application Moree Mobile Remote (Android et IOS)
	Fonctions	<ul style="list-style-type: none"> • Programmes de scènes et de couleurs • Paramètres de lumière multicolores et blancs • Module WIFI intégré • Interrupteur de synchronisation via l'application • Fonction dimmable par l'application • Compatible avec Google Home et Amazon Echo via contrôle vocal

1M COUNTER

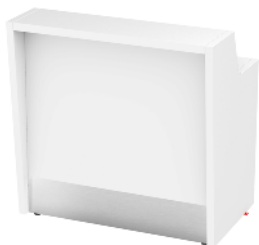

Andere Farben & Materialien
auf Anfrage möglich.
Other colours & Materials
available on request.
Autres couleurs et matériaux
disponibles sur demande.

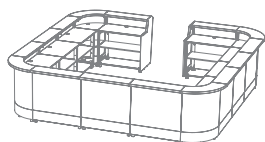

	1M COUNTER RADIUS	1M COUNTER EDGE
Modell Model Modèle	19-02-09	19-02-10
DE		
Material	Holz, beschichtet	Holz, beschichtet
Material Endstück	Holz, lackiert	Holz, beschichtet
Farbe	Weiß, seidenmatt	Weiß, seidenmatt
Maße	L700 x B1080 x H1060 mm	L700 x B1080 x H1060 mm
Gewicht	ca. 54 kg	ca. 54 kg
Energieeffizienz-Klasse	G	G
Front- & Arbeitsplatz-Beleuchtung	Eingebaute LED-Einheit (ausbaubar) 2x 10 W, 2x 370 lm	Eingebaute LED-Einheit (ausbaubar) 2x 10 W, 2x 370 lm
Fernbedienung	Funk	Funk
Ladegerät	-	-
Verkabelung	ca. 4 m, schwarz	ca. 4 m, schwarz
Spannung	200-240 VAC, 50 Hz	200-240 VAC, 50 Hz
Schutzklasse	II	II
Für Innenbereich	Ja	Ja
EN		
Material	Wood, laminated	Wood, laminated
Material Endcaps	Wood, spray painted	Wood, laminated
Colour	Satin white	Satin white
Dimensions	L700 x W1080 x H106 mm	L700 x W1080 x H1060 mm
Weight	approx. 54 kg	approx. 54 kg
Energy Class	G	G
Illuminant front/ workspace	Built-In LED Unit (removable) 2x 10 W, 2x 370 lm	Built-In LED Unit (removable) 2x 10 W, 2x 370 lm
Remote Control	Radio	Radio
Charger	-	-
Cable	approx. 4 m, black	approx. 4 m, black
Voltage	200-240 VAC, 50 Hz	200-240 VAC, 50 Hz
Protection Class	II	II
For Indoor Use	Yes	Yes
FR		
Matériaux	Bois, revêtement	Bois, revêtement
Matériaux Embouts	Bois, laqué	Bois, revêtement
Couleur	Blanc satiné	Blanc satiné
Dimensions	Lo 700 x La 1080 x H1060 mm	Lo 700 x La 1080 x H1060 mm
Poids	env. 54 kg	env. 54 kg
Classe Énergétique	G	G
Lumière led avant/ espace de travail	Unité à LED intégrée (amovible) 2x 10 W, 2x 370 lm	Unité à LED intégrée (amovible) 2x 10 W, 2x 370 lm
Télécommande	Radio contrôle	Radio contrôle
Chargeur	-	-
Câblage	env. 4 m, Noir	env. 4 m, noir
Tension	200-240 VAC, 50 Hz	200-240 VAC, 50 Hz
Catégorie	II	II
Pour Utilisation Intérieur	Oui	Oui

Mehr Informationen im Thekenkatalog online
Please read our bar catalogue online
Plus d'informations dans le catalogue en ligne
www.moree.de

60° COUNTER



Andere Farben & Materialien
auf Anfrage möglich.
Other colours & Materials
available on request.
Autres couleurs et matériaux
disponibles sur demande.

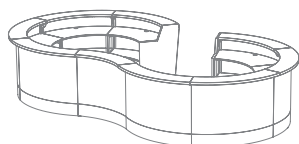

Modell | Model | Modèle

60° COUNTER RADIUS

19-02-11



DE	Material Material Endstück	Holz, beschichtet Holz, lackiert	Holz, beschichtet Holz, beschichtet
	Farbe	Weiß, seidenmatt	Weiß, seidenmatt
	Maße	L700 x B1515 x H1060 mm	L700 x B1520 x H1060 mm
	Gewicht	ca. 62 kg	ca. 62 kg
	Energieeffizienz-Klasse	G	G
	Front- & Arbeitsplatz-Beleuchtung	Eingebaute LED-Einheit (ausbaubar) 15 W, 560 lm/ 14 W, 500 lm	Eingebaute LED-Einheit (ausbaubar) 15 W, 560 lm/ 14 W, 500 lm
	Fernbedienung	Funk	Funk
	Ladegerät	-	-
	Verkabelung	ca. 4 m, schwarz	ca. 4 m, schwarz
	Spannung	200-240 VAC, 50 Hz	200-240 VAC, 50 Hz
	Schutzklasse	II	II
	Für Innenbereich	Ja	Ja

EN	Material Material Endcaps	Wood, laminated Wood, spray painted	Wood, laminated Wood, laminated
	Colour	Satin white	Satin white
	Dimensions	L700 x W1515 x H1060 mm	L700 x W1520 x H1060 mm
	Weight	approx. 62 kg	approx. 62 kg
	Energy Class	G	G
	Illuminant front/ workspace	Built-In LED Unit (removable) 15 W, 560 lm/ 14 W, 500 lm	Built-In LED Unit (removable) 15 W, 560 lm/ 14 W, 500 lm
	Remote Control	Radio	Radio
	Charger	-	-
	Cable	approx. 4 m, Black	approx. 4 m, Black
	Voltage	200-240 VAC, 50 Hz	200-240 VAC, 50 Hz
	Protection Class	II	II
	For Indoor Use	Yes	Yes

FR	Matériaux Matériaux Embouts	Bois, revêtement Bois, laqué	Bois, revêtement Bois, revêtement
	Coleur	Blanc satiné	Blanc satiné
	Dimensions	Lo 700 x La 1515 x H1060 mm	Lo 700 x La 1520 x H1060 mm
	Poids	env. 62 kg	env. 62 kg
	Classe Énergétique	G	G
	Lumière led avant/ espace de travail	Unité à LED intégrée (amovible) 15 W, 560 lm/ 14 W, 500 lm	Unité à LED intégrée (amovible) 15 W, 560 lm/ 14 W, 500 lm
	Télécommande	Radio contrôle	Radio contrôle
	Chargeur	-	-
	Câblage	env. 4 m, noir	env. 4 m, noir
	Tension	200-240 VAC, 50 Hz	200-240 VAC, 50 Hz
	Catégorie	II	II
	Pour Utilisation Intérieur	Oui	Oui







Mehr Informationen im Thekenkatalog online
Please read our bar catalogue online
Plus d'informations dans le catalogue en ligne







www.moree.de

LEGENDE TECHNISCHE SPEZIFIKATIONEN

LEGEND TECHNICAL SPECIFICATIONS | LÉGENDE CARACTERISTIQUES TECHNIQUES

					
E27 Fassung	LEDs warmweiss	LED-Leuchtmittel (Multicolor & Weiß)	Beleuchtung für Vorderseite & Arbeitsplatz	Eingebaute LED-Einheit (teilweise austauschbar)	LED-Einheit mit Schnellverschluss, magnetisch
E27 socket	LEDs warmwhite	LED source (Multicolor & White)	Front & workspace illumination	Built-In LED Unit (partly replaceable)	LED unit with fast lock (magnetic)
E27 douille de lampe	LED blanc chaud	Lampes LED (Multicolore et blanc)	Lumière pour avant et espace de travail	Unité à LED intégrée (en partie échangeable)	Unité LED avec fixation magnétique

					
Produkt mit Kabel	USB Port/Netzteil	Produkt mit Batterie	Solarmodul	Mit Fernbedienung	Dimmbar
Product with cable	USB Port/Adapter	Product with battery	Solar panel	With remote control	Dimmable
Produit avec câble	USB Port/Alimentation	Produit avec batterie	Panneau solaire	Avec télécommande	Dimmable

						
Verwendung im Innenbereich	Verwendung im Aussenbereich	Schutzart	Kabel-Stauraum	Ladestation	Magnetischer Schnellverschluss	Höhenverstellbar, 360° Rotation
Indoor use	Outdoor use	Ingress protection	Cable Organizer	Charging Station	Fast lock (magnetic)	Height adjustable, 360° rotation
Pour utilisation intérieur	Pour utilisation extérieur	Indice de protection	Stockage Câble	Station de Charge	Fixation magnétique	Réglable en hauteur, Rotation à 360°



Die Produkte Google Home/ Amazon ALEXA können zur Steuerung des 11W WLAN Moree-Leuchtmittels über Sprachbefehle durch Google Home App/ Amazon Alexa App in Kombination mit der **Moree Mobile Remote App** verwendet werden, die im iOS App Store oder Android Google Play verfügbar ist.

The products Google Home/ Amazon ALEXA can be used to control the Moree WIFI 11W Smart bulb through voice command via the Google Home app/ Amazon Alexa app in combination with the **Moree Mobile Remote app**, available on the iOS App Store or Android Google Play.

Les produits Google Home/ Amazon ALEXA peut être utilisé pour contrôler 11W l'ampoule Moree WIFI par commande vocale via Google Home app/ Amazon Alexa app en combinaison avec l'**application Moree Mobile Remote**, disponible sur l'iOS App Store ou Android Google Play.

KONTAKT

CONTACT | A CONTACTER

DE

MOREE Germany GmbH
Kaiserswerther Markt 11
40489 Düsseldorf
Deutschland

AUSSTELLUNG

An St. Swibert 42
40489 Düsseldorf
Deutschland

KUNDENSERVICE

Tel. +49 (0)211 302 768-0
Montag – Freitag 9-17:30
info@moree.de | www.moree.de

EN

MOREE Germany GmbH
Kaiserswerther Markt 11
40489 Düsseldorf
Germany

SHOWROOM

An St. Swibert 42
40489 Düsseldorf
Germany

CUSTOMER SERVICE

Tel. +49 (0)211 302 768-0
Monday - Friday 9 am-5:30 pm
info@moree.de | www.moree.de/en

FR

MOREE Germany GmbH
Kaiserswerther Markt 11
40489 Düsseldorf
Allemagne

SALE D'EXPOSITION

An St. Swibert 42
40489 Düsseldorf
Allemagne

SERVICE CLIENT

Tel. +49 (0)211 302 768-0
Du lundi au vendredi de 9 h à 17 h 30
info@moree.de | www.moree.de/fr

AKTUELLE INFORMATIONEN ZU UNSEREN
PRODUKTEN FINDEN SIE IM INTERNET:
www.moree.de

KATALOG RUNTERLADEN
<https://www.moree.de/katalog-moree-kollektion/>

MEDIEN
www.facebook.com/moree.de
www.instagram.com/moree_de/
www.moree.de/newsletter-abonnieren/

REFER TO OUR WEBSITE FOR THE LATEST
INFORMATION ABOUT OUR PRODUCTS:
www.moree.de/en

CATALOGUE DOWNLOAD
<https://www.moree.de/en/catalog-moree-collection/>

MEDIA
www.facebook.com/moree.de
www.instagram.com/moree_de/
www.moree.de/en/subscribe-to-newsletter/

CONSULTEZ NOTRE SITE WEB POUR LES
PLUS RÉCENTES MISES-À-JOUR SUR NOS
PRODUITS: www.moree.de/fr

TÉLÉCHARGEMENT DU CATALOGUE
<https://www.moree.de/fr/catalogue-collection-moree/>

MEDIA
www.facebook.com/moree.de
www.instagram.com/moree_de/
www.moree.de/fr/sabonner-a-la-newsletter/

Moree® ist markenrechtlich geschützt.
Änderungen an den Produkten vorbehalten. Jegliche
Haftung für den Fall von Irrtümern oder Auslassungen
wird ausgeschlossen.
Apple, das Apple-Logo und iPhone sind Warenzeichen
von Apple Inc., welche in den USA und anderen
Ländern eingetragen sind. App Store ist eine
Dienstleistungsmarke von Apple Inc..
Android ist ein Warenzeichen von Google Inc..
Amazon, Alexa und alle damit verbundenen Logos
sind Marken von Amazon.com, Inc. oder dessen
Tochtergesellschaften.
Unsere Dienste und Produkte werden nicht von Google
Inc. erstellt, mit ihr verbunden oder von ihr unterstützt.

Moree® is a Registered Trademark.
Changes to the products are reserved. All liability in case
of errors or omissions is excluded.

Apple, the Apple logo and iPhone are trademarks of
Apple Inc., registered in the U.S. and other countries.
App Store is a service mark of Apple Inc..

Android is a trademark of Google Inc..

Amazon, Alexa and all related logos are trademarks of
Amazon.com, Inc. or its affiliates.
Our services and products are not created by, affiliated
with, or supported by Google Inc..

Moree® est une marque déposée.
Tous changements aux produits sont réservés. Toute
responsabilité en cas d'erreur ou d'omission est exclue.

Apple, le logo Apple et iPhone sont des marques d'Apple
Inc., déposées aux États-Unis et d'autres pays. App
Store est une marque de service d'Apple Inc..

Android est une marque déposée de Google Inc..

Amazon, Alexa et tous les logos associés sont des
marques déposées d'Amazon.com, Inc. ou de ses filiales.
Nos services et produits ne sont pas créés, affiliés ou
pris en charge par Google Inc..

moree®
ENHANCING AMBIANCE



www.moree.de/en



230706 Moree Collection DE-EN-FRV6 ©2023 Moree Germany GmbH

moree®
ENHANCING AMBIANCE